

Digital Multi Switcher

MSD-V4 Series

MSD-V41U/MSD-V42U
MSD-V41UC/MSD-V42UC
MSD-V41UT/MSD-V42UT

Operation Guide
Ver.2.3.0

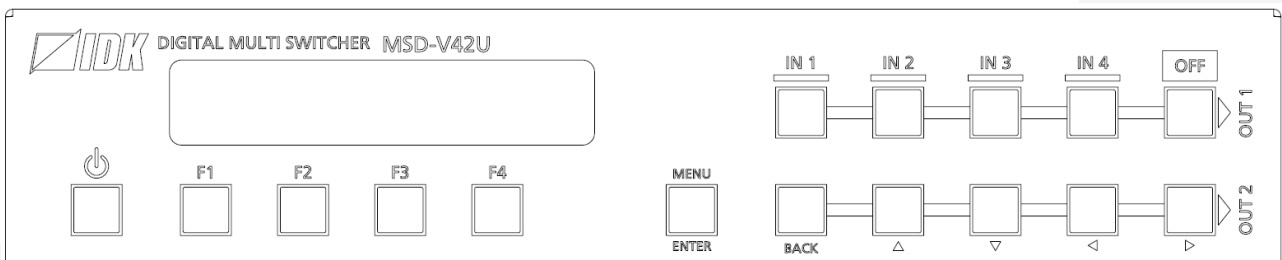
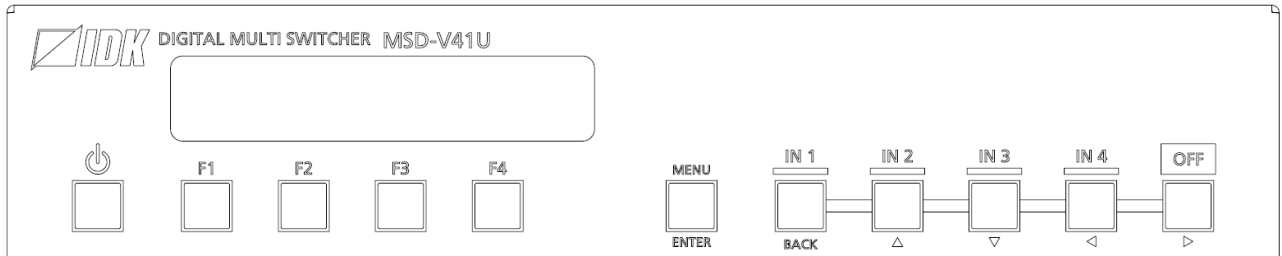

Thank you for choosing our product.

Please thoroughly familiarize yourself with this guide before installing this equipment. We recommend keeping this manual together with the equipment for future reference as needed.

- All rights reserved.
- Some information contained in this guide such as exact product appearance, communication commands, and so on may differ depending on the product version.
- This guide is subject to change without notice. You can download the latest version from IDK’s website at: www.idkav.com

About technical documentation

■ Please read the following guides before connecting this equipment to a power source.

<p>1. Safety Instructions Contains important safety instructions for the product to help ensure your own personal safety and protect the product and working environment from potential damage.</p>	<p>Provided with the product.</p>
<p>2. Setup Guide Contains setup information and precautions for installing the product and connecting cables.</p>	<p>Download from www.idkav.com</p>

■ Please refer to the following guides as needed.

<p>3. Operation Guide Describes how to configure and use the equipment.</p>	<p>Download from www.idkav.com</p>
<p>4. User Guide Contains detailed explanation of functions, setting values, and restrictions.</p>	
<p>5. Command Guide Contains information on controlling the equipment using communication commands through RS-232C or LAN communication.</p>	

Trademarks

- HDBaseT™ and the HDBaseT Alliance Logo are trademarks of the HDBaseT Alliance.
- The terms HDMI and HDMI High-Definition Multimedia Interface, and the HDMI Logo are trademarks or registered trademarks of HDMI Licensing Administrator, Inc. in the United States and other countries.
- SDVoE™ and SDVoE logo are trademarks of SDVoE Alliance.
- All other company and product names mentioned in this document are either registered trademarks or trademarks of their respective owners. In this document, the “®” or “™” marks may not be specified.
- ©2022 IDK Corporation, all rights reserved.

FCC STATEMENT

Note: This equipment has been tested and found to comply with the limits for a Class A digital device, pursuant to part 15 of the FCC Rules. These limits are designed to provide reasonable protection against harmful interference when the equipment is operated in a commercial environment. This equipment generates, uses, and can radiate radio frequency energy and, if not installed and used in accordance with the instruction manual, may cause harmful interference to radio communications. Operation of this equipment in a residential area is likely to cause harmful interference, in which case the user will be required to correct the interference at his own expense.

(Class A)

Supplier's Declaration of Conformity
47 CFR § 2.1077 Compliance Information

Unique Identifier

Type of Equipment: Digital Multi Switcher

Model Name: MSD-V41U, MSD-V42U, MSD-V41UC, MSD-V42UC, MSD-V41UT, MSD-V42UT

Responsible Party – U.S. Contact Information

Company Name: IDK America Inc.

Address: 72 Grays Bridge Road Suite 1-C, Brookfield, CT 06804

Telephone number: +1-203-204-2445

URL: www.idkav.com

FCC Compliance Statement

This device complies with Part 15 of the FCC Rules. Operation is subject to the following two conditions:
 (1) This device may not cause harmful interference, and (2) this device must accept any interference received, including interference that may cause undesired operation.

(FCC SDoC)

CE MARKING

This equipment complies with the essential requirements of the relevant European health, safety and environmental protection legislation.

WEEE MARKING

Waste Electrical and Electronic Equipment (WEEE), Directive 2002/96/EC
 (This directive is only valid in the EU.)



This equipment complies with the WEEE Directive (2002/96/EC) marking requirement.







The left marking indicates that you must not discard this electrical/electronic equipment in domestic household waste.

Safety Instructions

Read all safety and operating instructions before using this product. Follow instructions and heed warnings/cautions.

Instructions and warnings/cautions for all products are provided. Some of them may not be applicable to your product.

	<h2>Warning</h2>	Indicates the presence of a hazard that may result in death or serious personal injury if the warning is ignored or the product is handled incorrectly.
	<h2>Caution</h2>	Indicates the presence of a hazard that may cause minor personal injury or property damage if the caution is ignored or the product is handled incorrectly.

Symbol	Description	Example
 Caution	This symbol is intended to alert the user. (Warning and caution)	 Hot surfaces Caution
 Prohibited	This symbol is intended to prohibit the user from specified actions.	 Do not disassemble
 Instruction	This symbol is intended to instruct the user.	 Unplug

Warning

For lifting heavy products:

 Instruction	<ul style="list-style-type: none"> ● Lifting must be done by two or more personnel. <p>To avoid injury: When lifting the product, bend your knees, keep your back straight and get close to it with two or more persons.</p>
--	--

For installing and connecting products:





 Prohibited	<ul style="list-style-type: none"> ● Do not place the product in unstable place. <p>Install the product in a horizontal and stable place, as this may fall or tip over and cause injury.</p> <ul style="list-style-type: none"> ● Secure the product if installing in the locations with vibration. <p>Vibration may move or tip over the product unexpectedly, resulting in injury.</p>
---	--



Warning

 <p>Instruction</p>	<ul style="list-style-type: none"> ● Installation work must be performed by professionals. The product is intended to be installed by skilled technicians. For installation, please contact a system integrator or IDK. Improper installation may lead to the risk of fire, electric shock, injury, or property damage. ● Insert the power plug into an outlet that is unobstructed. Unobstructed access to the plug enables unplugging the product in case of any extraordinary failure, abnormal situation or for easy disconnection during extended periods of non-use. ● Insert the power plug into an appropriate outlet completely. If the plug is partially inserted, arcing may cause the connection to overheat, increasing the risk of electric shock or fire. Do not use a damaged plug or connect to a loose outlet. ● Unplug the product from an AC power source during installation or service. When connecting peripheral devices to this product, unplug all involved devices from outlets. Ground potential differences may cause fire or other difficulties. ● The product must be electrically earthed/grounded. To reduce the risk of electric shock, ensure the product is connected to a mains socket outlet with a protective earthing connection. ● For PoE/PoH, use category cables meeting IEEE802.3af/at. Otherwise, it may cause problems or a fire.
--	--

For operating products:

 <p>Prohibited</p>	<ul style="list-style-type: none"> ● Keep out any foreign objects. To avoid fire or electric shock, do not permit foreign objects, such as metal and paper, to enter the product from vent holes or other apertures. ● For power cable/plug and Category cable, <ul style="list-style-type: none"> • Do not scratch, heat, or modify, including splicing or lengthening them. • Do not pull, place heavy objects on them, or pinch them. • Do not bend, twist, tie or clamp them together forcefully. <p>Misuse of the power cable and plug may cause fire or electric shock. If power cables/plugs become damaged, contact your IDK representative.</p>
 <p>Do not disassemble</p>	<ul style="list-style-type: none"> ● Do not repair, modify or disassemble. Since the product includes circuitry that uses potentially lethal, high voltage levels, disassembly by unauthorized personnel may lead to the risk of fire or electric shock. For internal inspection or repair, contact your IDK representative.
 <p>Do not touch</p>	<ul style="list-style-type: none"> ● Do not touch the product and connected cables during electric storms. Contact may cause electric shock.
 <p>Instruction</p>	<ul style="list-style-type: none"> ● Clean the power plug regularly. If the plug is covered in dust, it may increase the risk of fire.



If the following problem occurs:

 <p>Unplug</p>	<ul style="list-style-type: none"> ● Unplug immediately if the product smokes, makes unusual noise, or produces a burning odor. ● Unplug immediately if the product is damaged by falling or having been dropped. ● Unplug immediately if water or other objects are directed inside. <p>If you continue to use the product under these conditions, it may increase the risk of electric shock or fire. For maintenance and repair, contact your IDK representative.</p>
---	--







Caution

For installing and connecting products:

 <p>Prohibited</p>	<ul style="list-style-type: none"> ● Do not place the product in a location where it will be subjected to high temperatures. If the product is subjected to direct sunlight or high temperatures while under operation, it may affect the product's performance and reliability and may increase the risk of fire. ● Do not store or operate the product in dusty, oil smoke filled, or humid place. Placing the product in such environment may increase the risk of fire or electric shock. ● Do not block the vent holes. If ventilation slots are blocked, it may cause the product to overheat, affecting performance and reliability and may increase the risk of fire. ● Do not place or stack heavy items on the product. Failure to observe this precaution may result in damage to the product itself as well as other property and may lead to the risk of personal injury. ● Do not exceed ratings of outlet and wiring devices. Exceeding the rating of an outlet may increase the risk of fire and electric shock.
 <p>No wet hands</p>	<ul style="list-style-type: none"> ● Do not handle power plug with wet hands. Failure to observe this precaution may increase the risk of electric shock.
 <p>Instruction</p>	<ul style="list-style-type: none"> ● Use and store the product within the specified temperature/humidity range. If the product is used outside the specified range of temperature and humidity continuously, it may increase the risk of fire or electric shock. ● Do not place the product at elevations of 1.24 mi. (2,000 m) or higher above sea level. Failure to do so may shorten the life of the internal parts and result in malfunctions. ● When mounting the product into the rack, provide sufficient cooling space. Mount the product in a rack meeting EIA standards, and maintain spaces above and below for air circulation. For your safety as required, attach an L-shaped bracket in addition to the panel mount bracket kit to improve mechanical stability. ● Never insert screws without the rubber feet into the threaded holes on the bottom of the product. Never insert screws alone into the threaded holes on the bottom of the product. Doing so may lead to damage when the screws contact electric circuitry or components inside the product. Reinstall the originally supplied rubber feet using the originally supplied screws only.

For operating products:

 Hot surfaces Caution	<p>For products with the hot surfaces caution label only:</p> <ul style="list-style-type: none"> ● Do not touch the product's hot surface. <p>If the product is installed without enough space, it may cause malfunction of other products. If you touch product's hot surface, it may cause burns.</p>
 Prohibited	<ul style="list-style-type: none"> ● Use only the supplied power cable and AC adapter. ● Do not use the supplied power cable and AC adapter with other products. <p>If non-compliant adapter or power cables are used, it may increase the risk of fire or electric shock.</p>
 Unplug	<ul style="list-style-type: none"> ● If the product won't be used for an extended period of time, unplug it. <p>Failure to observe this precaution may increase the risk of fire.</p> <ul style="list-style-type: none"> ● Unplug the product before cleaning. <p>To prevent electric shock.</p>
 Instruction	<ul style="list-style-type: none"> ● Do not prevent heat release. <p>If cooling fan stops, power off the product and contact IDK. Failure to do so may raise internal temperature and increase the risk of malfunction, fire, or electric shock.</p> <ul style="list-style-type: none"> ● Keep vents clear of dust. <p>If the vent holes near the cooling fan or near the fan are covered with dust, internal temperatures increase and may increase the risk of malfunction. Clean the vent holes and near the fan as needed. If dust accumulates inside of the product, it may increase the risk of fire or electric shock. Periodic internal cleaning, especially before humid rainy season, is recommended. For internal cleaning, contact your IDK representative.</p>

Contents

About this Guide	10
Conventions	10
About this Product	11
Provided items	11
Panel overview	12
Precautions for Installation	14
Connection Details	15
Connecting HDMI devices	15
Connecting 10GbE devices	16
Connecting HDBaseT devices	17
Connecting to analog devices	18
Control connections	19
Advanced menu	20
Front Panel Operations	21
Powering up	21
Switching power state to standby	21
Selecting menu	22
Switching video/audio	23
Setting function button mode	24
Setting front panel security lockout	25
WEB Browser Operation	26
Displaying WEB GUI	26
Changing settings via WEB browser	27
Controlling MSD-V4 via WEB browser	28
Editing crosspoint name	29
Enabling WEB GUI login	30
Logging in of WEB GUI	32
Logging out of WEB GUI	33
Setting Video Attributes	34
Changing output resolution	35
Adjusting image position	36
Adjusting image size	37
Displaying input video on full screen	38
Displaying input video dot-by-dot	40
Displaying video on non-HDCP compliant sink device	41
Enabling Deep Color input	42
Enabling Deep Color output	43
Outputting test patterns	44
Setting Audio	45
Adjusting Audio Level	45
Embedding analog input audio	46
De-embedding audio	46
Enabling multichannel audio input	47
Enabling multichannel audio output	48
Downmixing multichannel LPCM input audio	49
Enabling Bitstream audio	50
Outputting test tone	51
EDID	52

Selecting EDID.....	52
Changing supported resolution of built-in EDID	53
Copying EDID of sink device	54
Picture in Picture	55
Displaying PinP window.....	55
Switching PinP video.....	56
Switching window layout	58
Bitmap.....	60
Storing bitmap file.....	61
Displaying a bitmap	62
Displaying bitmap when an input is set to OFF	63
Displaying bitmap when no video signal is present at input	64
Automatic Input Switching	65
Configuring automatic input switching	65
Automatic input switching – Setting response delay interval	67
RS-232C/LAN Communication	68
Configuring RS-232C communication	68
Configuring LAN communication.....	69
Projector Power Control	70
Controlling projector power via RS-232C communication	70
Controlling projector power via PLink (LAN communication)	74
Screen Control	79
Viewing Status	82
Viewing input signal status.....	82
Viewing output signal status	83
Viewing sink device EDID	84
Storing and Recalling Presets.....	85
Storing settings in preset memory.....	85
Recalling stored settings from preset memory	86
Storing input selection settings to crosspoint memory	87
Recalling stored input selection settings from crosspoint memory	88
Storing layouts in pattern memory	89
Recalling stored layouts from pattern memory	90
Recalling presets at start-up.....	91
Backup and Restore	92
Backing up settings	92
Restoring settings from backup file.....	93
Initialization	94
Initializing all settings.....	94
Initializing settings other than LAN/RS-232C configurations.....	95
Other useful features.....	96
Enabling sink device to enter standby mode.....	96
Troubleshooting	97

About this Guide

This guide describes how to configure and use the MSD-V4 Digital Multi Switcher.

In this guide, all operations and configurations are provided based on MSD-V42U/MSD-V42UC/MSD-V42UT. The available menus and settings depend on the switcher model.

Operations are described based on the front panel operation, and information for the WEB GUI is also included for each operation.

Conventions

- The following terms are used in this guide.
 - PC : Personal computer
 - WEB GUI : Graphic User Interface (GUI) displayed through a WEB browser.
 - OUT A : OUT 1A connector or OUT 2A connector
 - OUT B : OUT 1B connector or OUT 2B connector
 - OUT 1 : Output channel for simultaneous distribution of a single source signal to OUT 1A and OUT 1B
 - OUT 2 : Output channel for simultaneous distribution of a single source signal to OUT 2A and OUT 2B
 - INOFF : Input channel OFF
- The following symbols are used in this guide.
 - [] : Menus and messages displayed on the front panel display and a WEB GUI.
 - “ ” : Reference
- The following notifications are used in this guide.
 - Note** : Addresses practices not related to personal injury, such as restrictions and attention.
 - Tip** : Provides supplemental remarks and suggestions.

About this Product

The MSD-V4 series is a digital presentation switcher with built-in scalers and scan converters capable of sending processing and receiving UHD video resolution formats.

With four (4) HDMI/DVI video inputs, the series can accept a wide variety of video formats. Input video signals are output as HDMI signals at up to 4K@60 (4:4:4). The MSD-V41UC/V42UC and MSD-V41UT/V42UT output signals in HDMI format and either 10GbE (IP-NINJAR protocol) or HDBaseT simultaneously.

With four (4) HDMI and one (1) analog audio inputs, audio source signals are distributed in digital and analog audio formats simultaneously.

The MSD-V4 series can be configured remotely using RS-232C or LAN.

External devices can be controlled via RS-232C, LAN, CEC, or contact closure by registering control commands.

Provided items

Ensure that all items illustrated below are included in the package.

If any items are missing or damaged, please contact IDK.

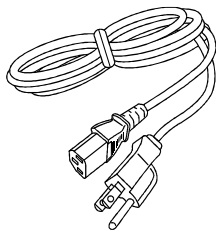

One (1) power cord, 6 ft. (1.8 m)

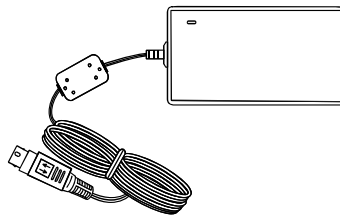

One (1) AC adapter (4 ft. (1.2 m))

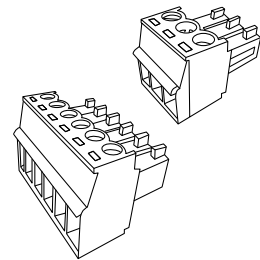

Three (3) 3-pin captive-screw terminal blocks

One (1) 6-pin captive-screw terminal block

Panel overview

Front panel

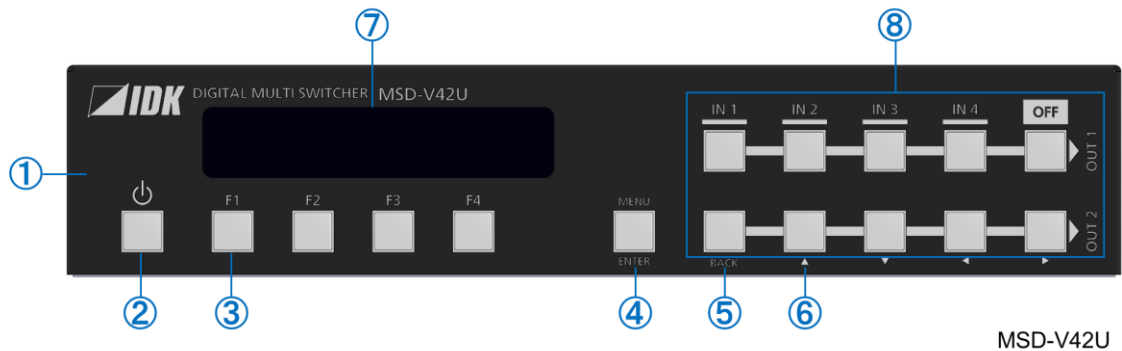

①	Front panel User accessible control buttons and front panel display
②	Power button Power mode control: ON/OFF/STANDBY
③	Function button (F button) Executes user assigned functions.
④	MENU/ENTER button Displays a menu or submenu. Selects a menu or accepts a new setting.
⑤	BACK button Returns to the previous page. (When a menu is displayed.)
⑥	Navigation buttons (△▽◀▶) Menu and attribute selection. (When a menu is displayed.) Moves the cursor. Value and action selection.
⑦	Front panel display Displays menus, parameters, or setting values.
⑧	Input selection buttons Selects inputs.

Rear panel

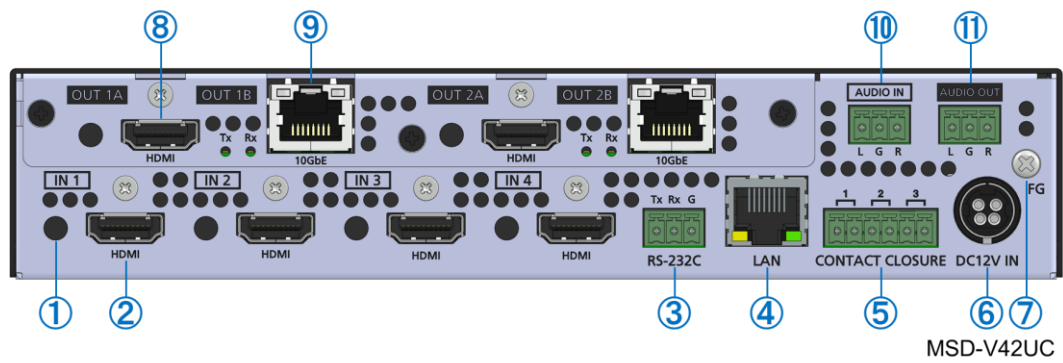

①	Hole for HDMI cable clamp (Not used)
②	HDMI input
③	RS-232C
④	LAN
⑤	CONTACT CLOSURE
⑥	DC Power
⑦	Frame ground (M4 screw)
⑧	HDMI output
⑨	MSD-V41UC/V42UC : 10GbE output MSD-V41UT/V42UT : HDBaseT output MSD-V41U/V42U : N/A
⑩	Analog audio input
⑪	Analog audio output

Precautions for Installation

- Grounding (Earthing) is required. Connect the FG (Frame Ground) connector to a local electrical ground bonding point.
- When installing the MSD-V4, observe the following precautions; otherwise, the internal temperature increases, possibly affecting product reliability and operation.
 - Do not stack or place one MSD-V4 directly on top of another MSD-V4.
 - Do not block vent holes.
 - Maintain sufficient clearances around the MSD-V4 (1.2 in. (30 mm) or more) to provide adequate ventilation.
 - It is advisable to install the MSD-V4 in an environment compatible with the maximum temperature indicated in the specification sheet 32°F to 104°F (0°C to +40°C).
 - If mounting the MSD-V4 on an optional IDK rack system, refer to its User Guide for details.
- Insert the DC plug into the power inlet connector of the MSD-V4 until it clicks.
Hold the connector as illustrated below when unplugging the DC plug.

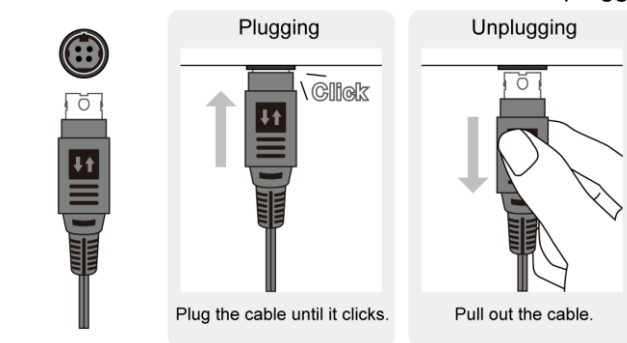

Connection Details

When connecting the MSD-V4 to external devices, observe the following precautions.

Notes

- Before connecting cables to the MSD-V4 or an external device, dissipate static electricity by touching grounded metal such as equipment racks before handling signal cables. Failure to observe this precaution may result in ESD (electrostatic discharge) damage.
- Power off or disconnect all related devices before connecting cables.
- Be sure to fully seat all plugs and connections and dress cables to reduce stress on connectors.

Connecting HDMI devices

Connect the MSD-V4 to HDMI devices using HDMI cables.

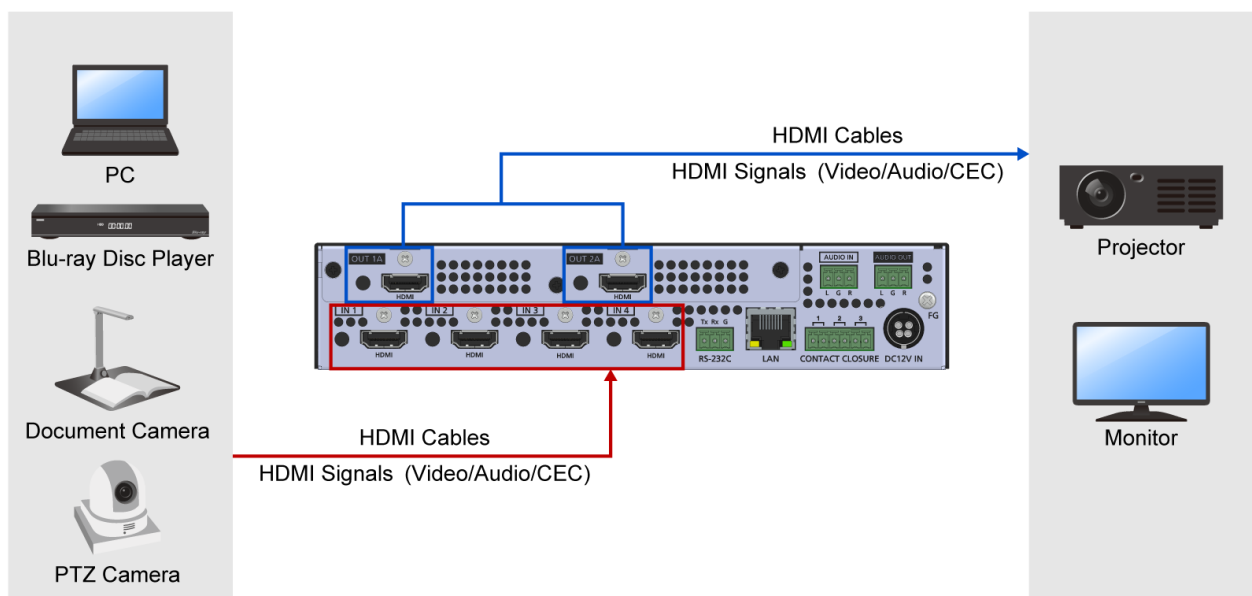

Notes

- Video may be interrupted or may not be output depending on cable type, cable quality, cabling condition, connected device type, and installation environment.
- A problem may occur if a cable joint is used for HDMI cable extension.

Cable Lacing Bracket (FB-01 For IDK products only)

Use the cable lacing bracket to secure a standard HDMI cable as shown.

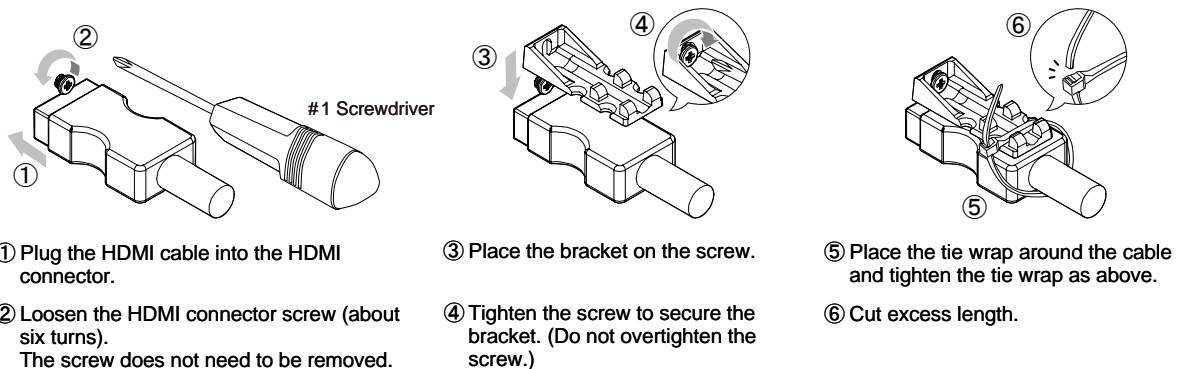

Connecting 10GbE devices

Connect the MSD-V4 to 10GbE (SDVoE) devices or network devices using twisted pair cables (CAT6A).

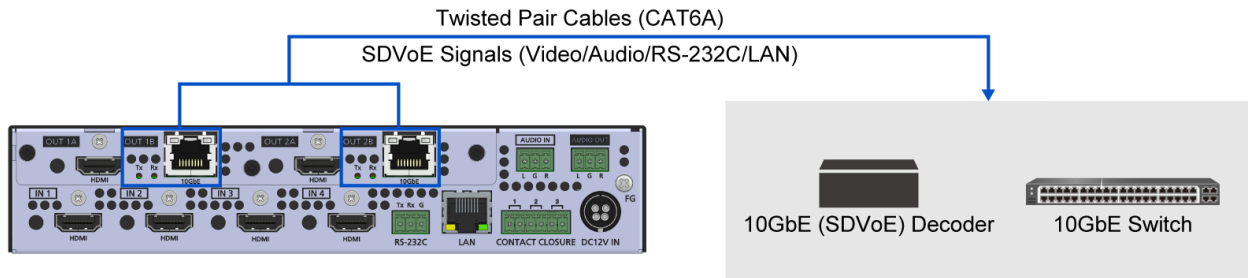

Notes

- For transmission over 10GbE, use the MSD-V4 in combination with IDK's SDVoE-enabled products.
- If SDVoE signal is sent via a network with a 10GbE switch connected, control from the IP-NINJAR management platform is needed.
- Up to two CAT6A (10GBase-T) cable joiners can be used, but the maximum transmission distance may be shortened by about 10%.

For twisted pair cable (CAT6A)

- To achieve full transmission distances and reduce transmission errors, select a high-quality twisted pair cable type, ensuring that proper pinning and pairing requirements are observed.
 - Use STP cables with fully shielded connectors.
 - Connect the FG (frame ground) connector of the MSD-V4 and connected devices to a local electrical ground bonding point.
- Determine which pairing-pinning standard will be used, T568A or T568B to use.
- Do not pull the cable using excessive force.
- Do not bend the cable at a sharp angle. Keep the bend radius four times the cable diameter or larger.
- Do not clamp or tie the cable tightly; leave some space allowing the cable to move slightly.
- If you use multiple twisted pair cables, keep a distance between the cables and avoid installing the cables directly in parallel.
- Keep the twisted pair cable running as straight as possible. Looping or coiling the cable causes it to be more easily affected by noise; especially when using longer cable run lengths.

Connecting HDBaseT devices

Connect the MSD-V4 to HDBaseT devices using twisted pair cables (CAT5e/CAT6).

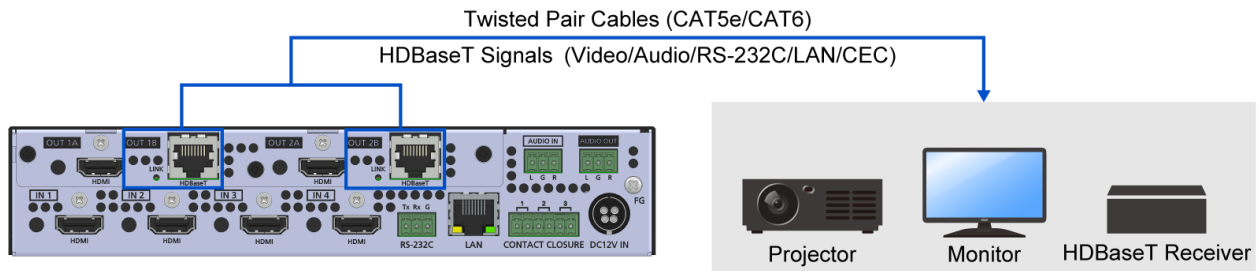

Notes

- The shape of HDBaseT connectors is the same as that of RJ-45 connectors. However, the MSD-V4 cannot be connected to an Ethernet device since the signal protocol is not compatible.
- Up to two CAT6A (10GBase-T) cable joiners can be used, but the maximum transmission distance may be shortened by about 10%.

For twisted pair cable (CAT5e/CAT6)

- To achieve full transmission distances and reduce transmission errors, select a high-quality twisted pair cable type, ensuring that proper pinning and pairing requirements are observed.
 - Use STP cables with fully shielded connectors.
 - Connect the FG (frame ground) connector of the MSD-V4 and connected devices to a local electrical ground bonding point.
- Determine which pairing-pinning standard will be used, T568A or T568B to use.
- Do not pull the cable using excessive force.
- Do not bend the cable at a sharp angle. Keep the bend radius four times the cable diameter or larger.
- Do not clamp or tie the cable tightly; leave some space allowing the cable to move slightly.
- If you use multiple twisted pair cables, keep a distance between the cables and avoid installing the cables directly in parallel.
- Keep the twisted pair cable running as straight as possible. Looping or coiling the cable causes it to be more easily affected by noise; especially when using longer cable run lengths.

Connecting to analog devices

Connect the MSD-V4 to analog audio devices over audio cables.

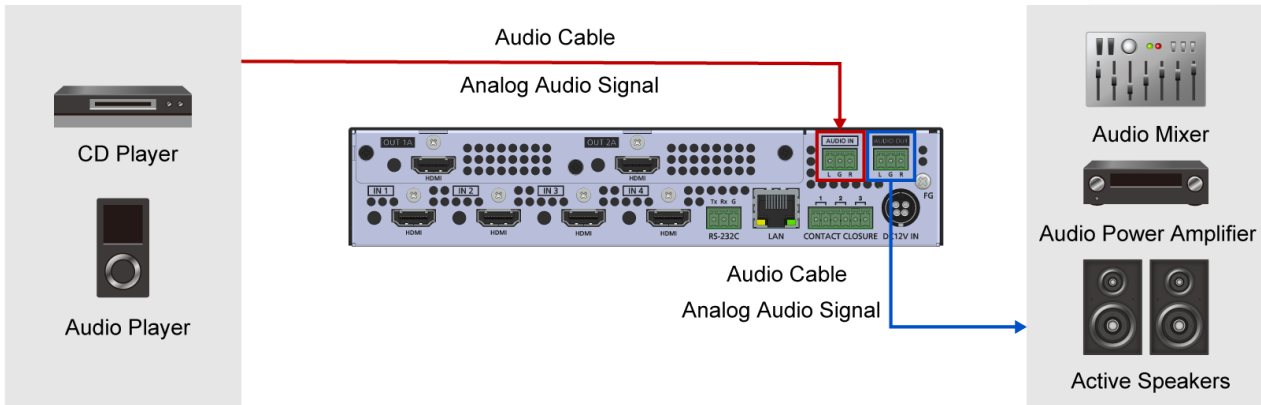

Tip

Connect the captive-screw terminal blocks to audio cable as follows:

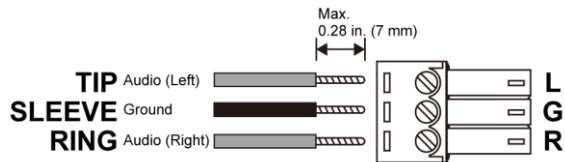

28 AWG to 16 AWG conductor cabling is recommended.

The length of the exposed wire after stripping is 0.28 in. (7 mm) at maximum.

Control connections

Connect the MSD-V4 to external devices over LAN/RS-232C to control the MSD-V4 from external devices.

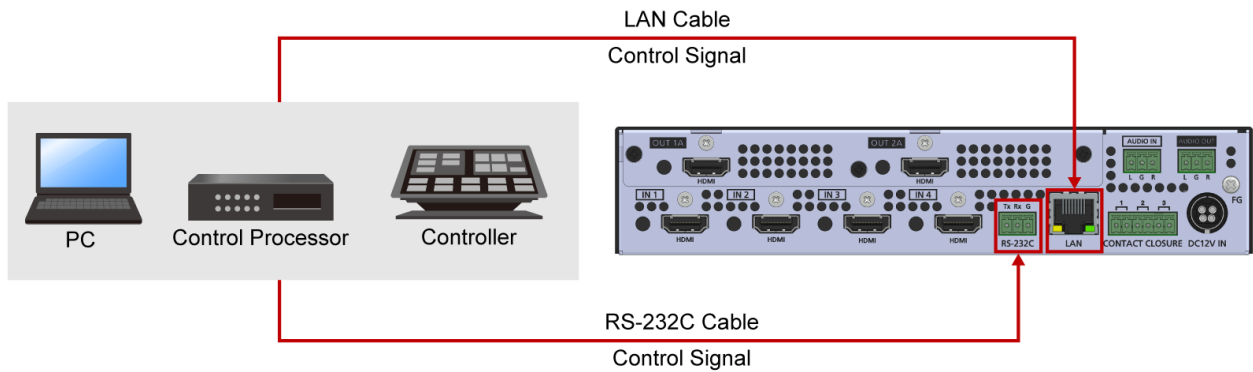

Connect the MSD-V4 to external devices over LAN/RS-232C to control external devices from the MSD-V4.

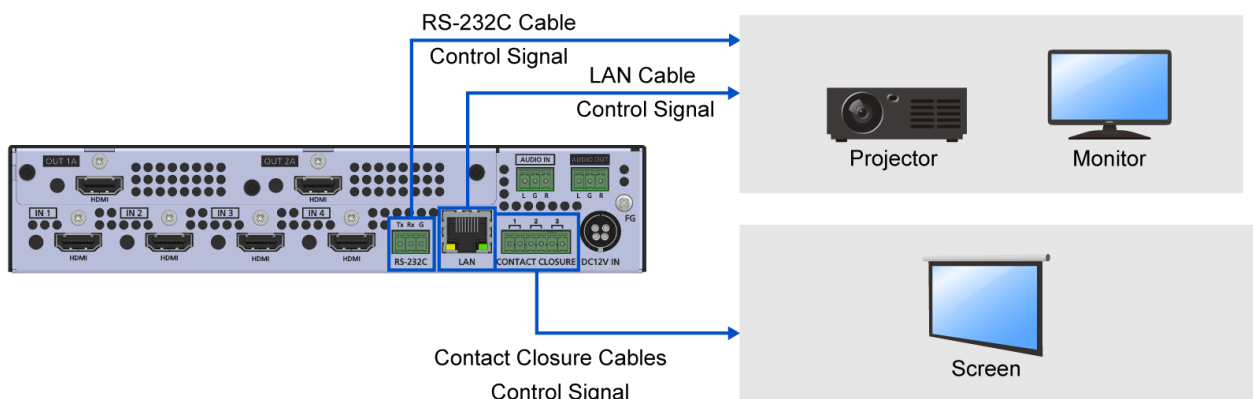

Tip

Connect the captive-screw terminal blocks to LAN/RS-232C cables as follows:

RS-232C cable

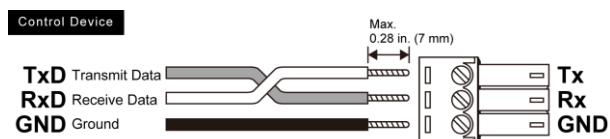

28 AWG to 16 AWG conductor cabling is recommended.

The length of the exposed wire after stripping is 0.28 in. (7 mm) at maximum.

Contact closure connector cable

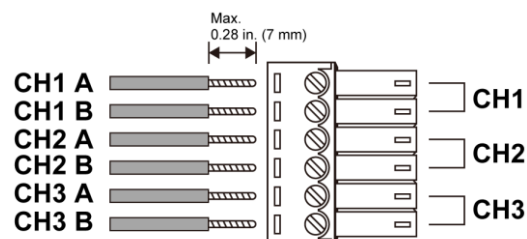

28 AWG to 16 AWG conductor cabling is recommended.

The length of the exposed wire after stripping is 0.28 in. (7 mm) at maximum.

Advanced menu

The menu structure consists of frequently used basic menus and advanced menus. Only the basic menus are displayed by default.

This section describes how to display both basic and advanced menus.

For sections that describe an advanced menu, the **Advanced** indication below is included at the lower right area of the section title.

Advanced

Front Panel

1. Select [SYSTEM SETTINGS]→[ADVANCED MENU].
2. Select [ON].

WEB GUI

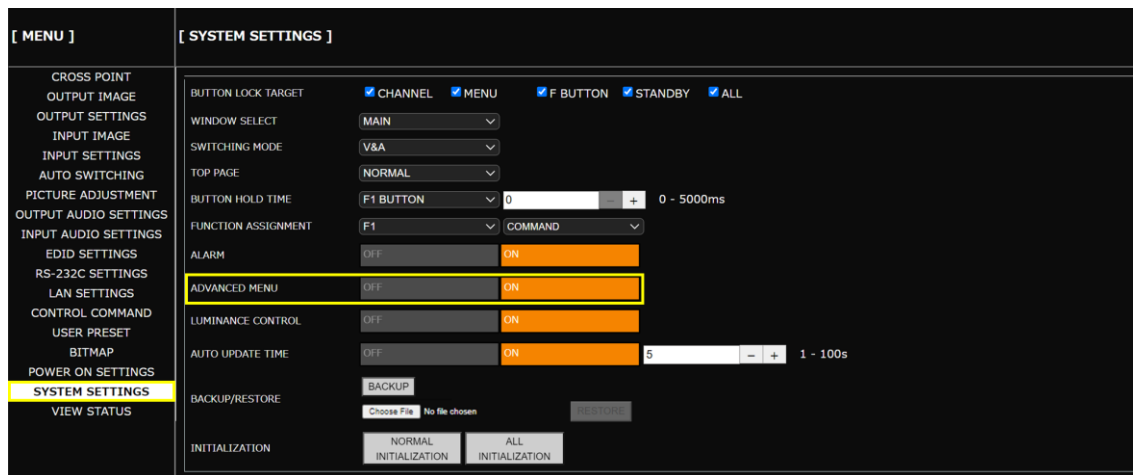

Front Panel Operations

This chapter contains information on the front panel operation and security lock.

The color of the power button LED indicates the power state of the MSD-V4.

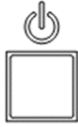

Not lighted: No power



Amber: Standby



Green: Powered on

Note

Power on the MSD-V4 after connecting all cables.

Press the MENU/ENTER button or BACK button to switch available operations. The color of the MENU/ENTER button LED indicates available operation.

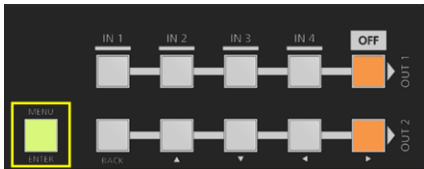

Lights solid green: Input channel selection

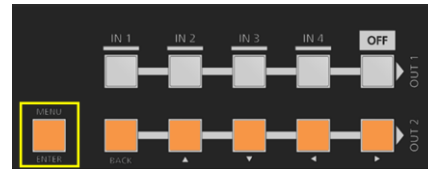

Lights solid amber: Menu operation

Powering up

1. Press the power button.

When boot-up is complete, the power button LED lights solid green.

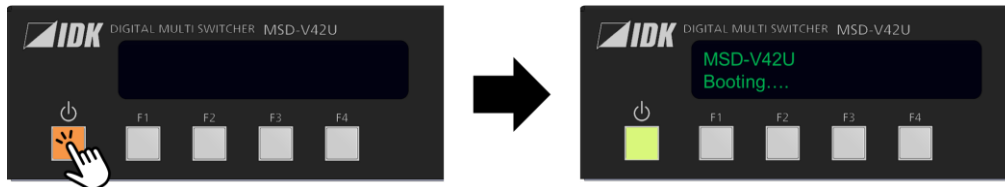

Notes

- It takes 12 seconds at maximum to be ready for normal operation after powering up.
- If the power button does not light, power is not supplied. Ensure that the supplied AC power cable is connected.

Switching power state to standby

1. Press and hold the power button for one second.

When the MSD-V4 enters standby mode, the power button LED lights solid amber.

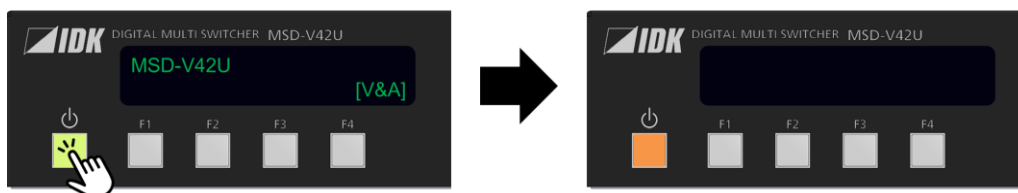

Selecting menu

Use the following buttons (Only the lighted buttons are available in each menu session):

- MENU/ENTER button : Accesses currently selected submenus or submenu items.
- BACK button : Exits currently selected submenus or submenu items.
- Navigation buttons : Changes values of adjustable features or navigates the menus/submenus.

When the MENU/ENTER button is flashing, press the MENU/ENTER button to accept the selected value(s).

When device name is displayed on the top page:

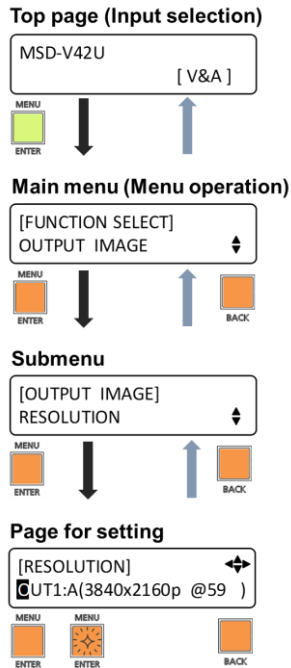

When values other than device name is displayed on the top page:

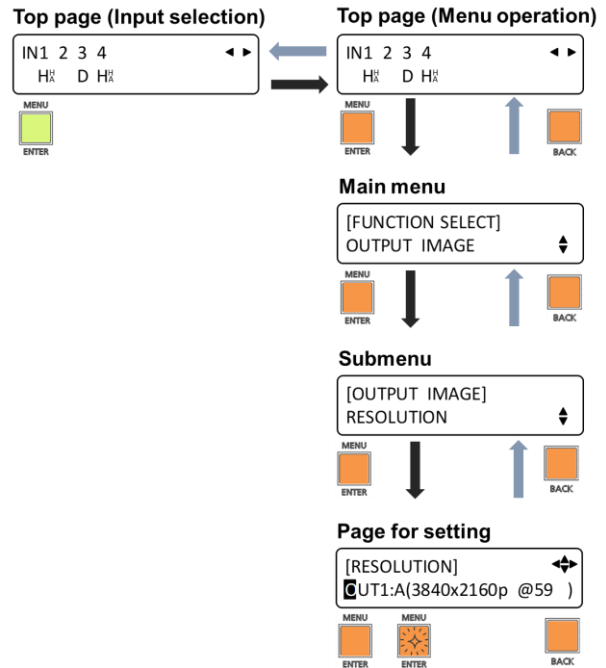

Tip

Only basic menus are displayed by default. To display advanced menus as well, perform the procedure in “Advanced menu (P.20)”.

Switching video/audio

1. Press the input selection button.

The values displayed in the lower-right corner of the front panel display indicates which source is switched.



- [V&A] : Switches video and audio simultaneously.
- [VIDEO] : Switches video only.
- [AUDIO] : Switches audio only.

The illumination color of the input selection buttons indicate which signal is currently selected.

- Lights solid amber : Video and audio are selected.
- Lights solid green : Only video is selected.
- Lights solid red : Only audio is selected.

Switching video and audio simultaneously

1. Select [SYSTEM SETTING]→[SWITCHING MODE].
2. Select [V&A].
3. Press the BACK button until the MENU/ENTER button LED lights solid green.
4. Press the input selection button.

Example:

The front panel below shows:

- IN2 is selected to OUT1 and IN3 is selected to OUT2.
- Video and audio are switched simultaneously.



Switching video and audio separately

1. Select [SYSTEM SETTING]→[SWITCHING MODE].
2. Select the signal to switch.
[VIDEO] : Switches video only.
[AUDIO] : Switches audio only.
3. Press the BACK button until the MENU/ENTER button LED lights solid green.
4. Press the input selection button to switch the signal selected in step 2.

Example:

The front panel below shows:

- IN4 is selected to OUT1.
- Only audio is switched.

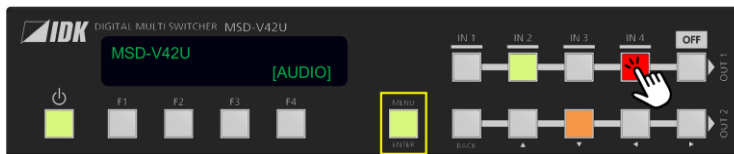

Setting function button mode

1. Select [SYSTEM SETTING]→[FUNCTION ASSIGNMENT].
2. Select the function button.
3. Select the function mode.
 - [COMMAND] : Executes assigned control commands.
 - [DISPLAY POWER] : Executes control commands assigned to buttons for controlling power of sink devices.
 - [PATTERN] : Recalls the stored pattern memory in order.
 - [WINDOW SELECT] : Switches main window or PinP window that is changed when an input selection button is pressed.
 - [CROSSPOINT] : Recalls the stored crosspoint memory.
 - [PRESET MEMORY] : Recalls the stored preset memory.

Notes

- If [COMMAND] is selected, the front panel buttons are disabled during the command execution.
- If [DISPLAY POWER] is selected, function buttons to which [DISPLAY POWER] is assigned are activated even during the command execution.

Tips

- To control projector power state using a function button, perform the procedure in “**Projector Power Control (P.70)**”.
- To control screens using a function button, perform the procedure in “**Screen Control (P.79)**”.
- For details regarding pattern memory, crosspoint memory, and preset memory, see “**Storing and Recalling Presets (P.85)**”.
- For details regarding control command assignment, refer to the User Guide.

Setting front panel security lockout

Enabling front panel security lockout

1. Press and hold the MENU/ENTER button for two seconds.

When the lockout is enabled, a message, [Button Lock !] appears on the front panel display.

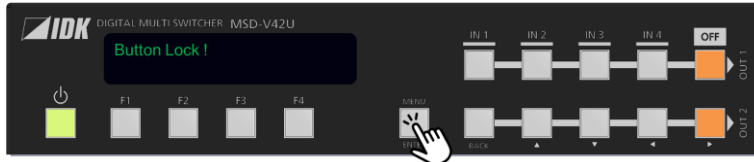

Tip

Only the standby and input buttons will light after enabling front panel security lockout. During lockout, the other buttons will not light. LEDs of locked buttons other than the power button and input selection buttons turn off.

Disabling front panel security lockout

1. Press and hold the MENU/ENTER button for two seconds.

When the lockout is disabled, a message, [Button Lock Release !] appears on the front panel display.



Selecting button lock target

1. Select [SYSTEM SETTINGS]→[BUTTON LOCK TARGET].
2. Select the button groups to be locked.
 - [STANDBY] : Power button
 - [F BUTTON] : Function button
 - [CHANNEL] : Input selection buttons
 - [MENU] : MENU/ENTER button

Tip

For function buttons, the press-and-hold time can also be set manually to prevent accidental operation. For details, refer to the User Guide.

WEB Browser Operation

This chapter describes how to control the MSD-V4 via a WEB browser of a connected PC.

Displaying WEB GUI

1. Configure network settings for the PC before connecting to the MSD-V4.

If the MSD-V4's IP address is set to its default, set the internet protocol version 4 (TCP/IPv4) of the PC.

Example

IP address : 192.168.1.100

Subnet mask : 255.255.255.0

Default gateway : No character

2. Connect the MSD-V4's LAN connector to the PC.
3. Open a WEB browser on the connected PC.
4. Enter the IP address of the MSD-V4 into the address bar of the WEB browser.

Note that the default IP address is 192.168.1.199.

Note

JavaScript of WEB browser needs to be activated to display the WEB GUI.

Tip

See "**Configuring LAN communication (P.69)**" for setting or viewing the MSD-V4's IP address.

Changing settings via WEB browser

Advanced

1. Select the main menu (①).
2. Select the output window (②).
3. Select or specify the desired values (③).

To initialize the image settings, click the [INITIALIZATION] button.

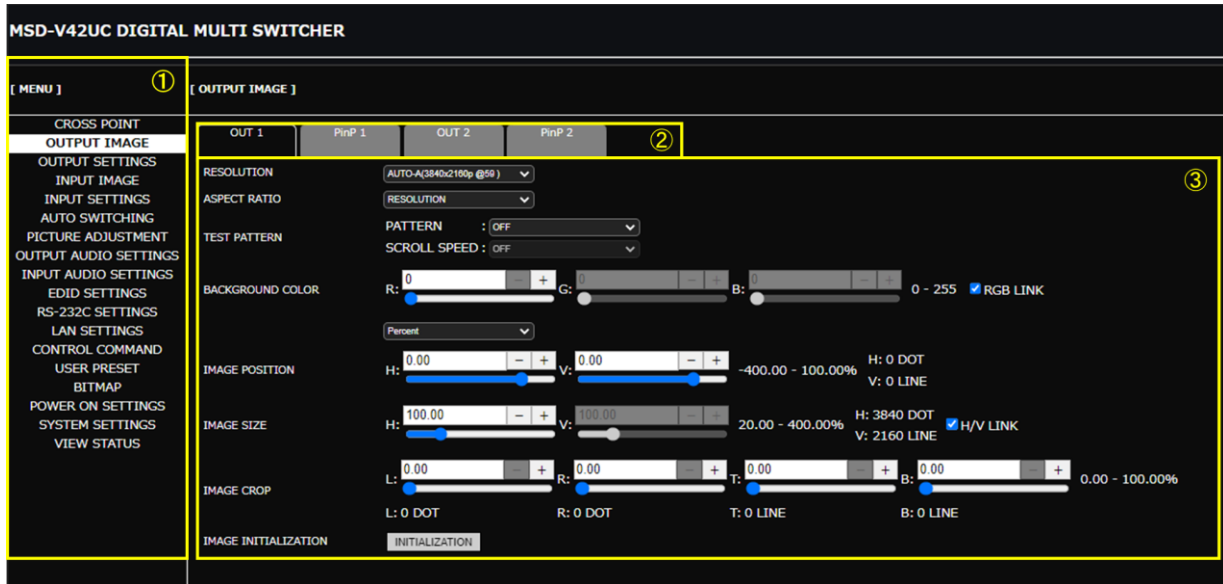

Tip

Only basic menus are displayed by default. To display advanced menus as well, perform the procedure in “Advanced menu (P.20)”.

Controlling MSD-V4 via WEB browser

1. Select [MENU]→[CROSS POINT].
2. Select or specify the desired values.

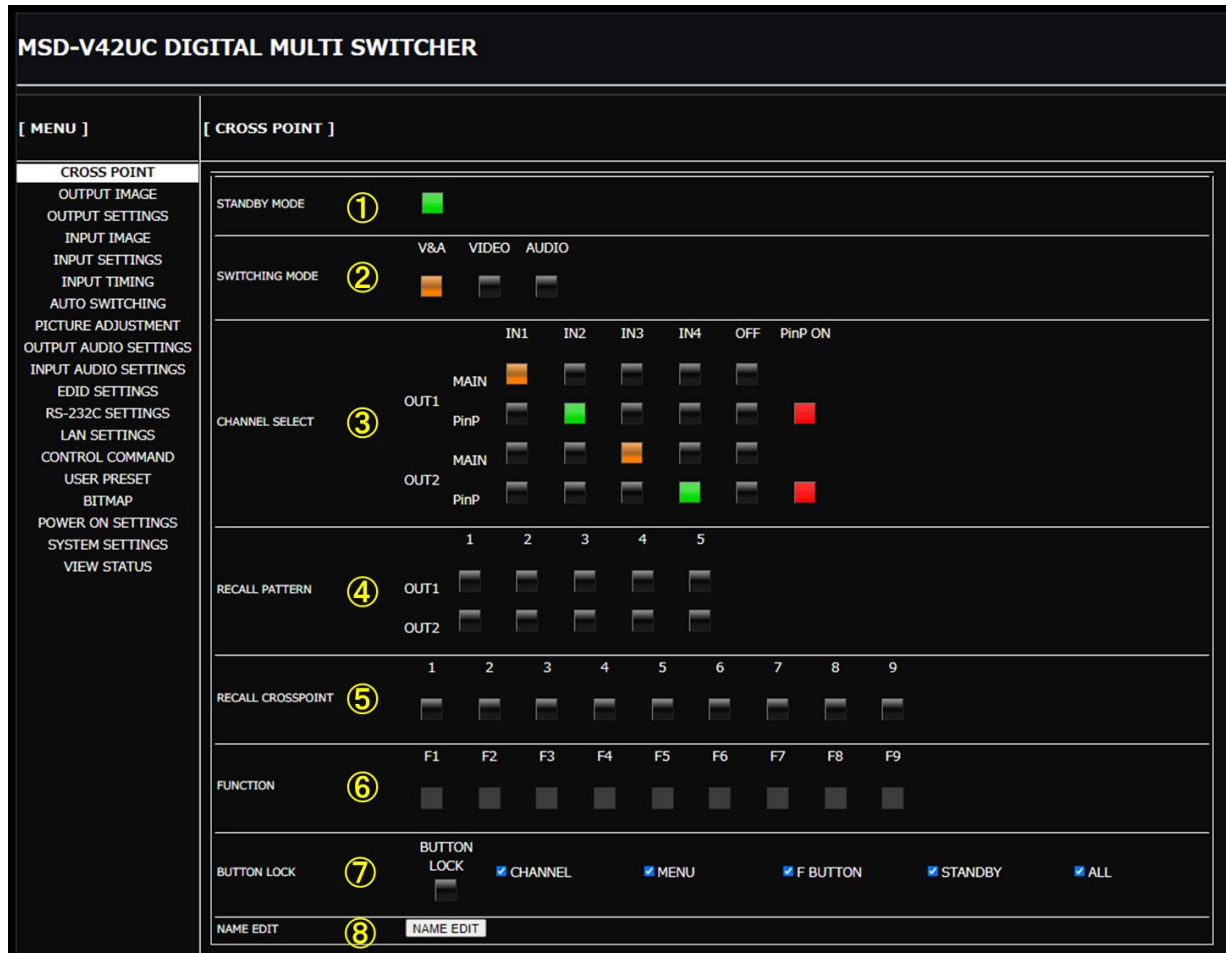

①	[STANDBY MODE]	Switches the power state.
②	[SWITCHING MODE]	Selects the signal to be switched when an input is selected.
③	[CHANNEL SELECT]	Selects input video and audio signals. Enables/disables PinP window display.
④	[RECALL PATTERN]	Recalls patterns stored in the MSD-V4.
⑤	[RECALL CROSSPOINT]	Recalls crosspoint settings stored in the MSD-V4.
⑥	[FUNCTION]	Executes the functions assigned to the function button.
⑦	[BUTTON LOCK]	Selects button group(s) to be locked/unlocked. Enables/disables button lock.
⑧	[NAME EDIT]	Edits input names and other items displayed on WEB GUI.

Editing crosspoint name

1. Select [MENU]→[CROSS POINT].
2. Click the [NAME EDIT] button from [CROSSPOINT] to open the [NAME EDIT] window.
3. Enter the desired name(s).

INPUT1	IN1
INPUT2	IN2
INPUT3	IN3
INPUT4	IN4
OUTPUT1	OUT1
OUTPUT2	OUT2
FUNCTION1	F1
FUNCTION2	F2
FUNCTION3	F3
FUNCTION4	F4
FUNCTION5	F5
FUNCTION6	F6
FUNCTION7	F7
FUNCTION8	F8
FUNCTION9	F9
DEVICE	MSD-V42UC DIGITAL MUL

① Input channel names:
Up to 10 one-byte characters.

② Output channel names:
Up to 10 one-byte characters.

③ Function button name:
Up to 10 one-byte characters.

④ Device name:
Up to 40 one-byte characters.

4. Click the [×] button to close the [NAME EDIT] window.

MSD-V42UC DIGITAL MULTI SWITCHER ④

[MENU]	[CROSS POINT]
CROSS POINT	STANDBY MODE <input type="checkbox"/>
OUTPUT IMAGE	V&A VIDEO AUDIO
OUTPUT SETTINGS	SWITCHING MODE <input type="checkbox"/> <input type="checkbox"/> <input type="checkbox"/>
INPUT IMAGE	IN1 IN2 IN3 IN4 OFF PinP ON
INPUT SETTINGS	OUT1 MAIN <input type="checkbox"/> <input type="checkbox"/> <input type="checkbox"/> <input type="checkbox"/> <input type="checkbox"/> <input type="checkbox"/>
INPUT TIMING	PinP <input type="checkbox"/> <input type="checkbox"/> <input type="checkbox"/> <input type="checkbox"/> <input type="checkbox"/> <input type="checkbox"/>
AUTO SWITCHING	OUT2 MAIN <input type="checkbox"/> <input type="checkbox"/> <input type="checkbox"/> <input type="checkbox"/> <input type="checkbox"/> <input type="checkbox"/>
PICTURE ADJUSTMENT	PinP <input type="checkbox"/> <input type="checkbox"/> <input type="checkbox"/> <input type="checkbox"/> <input type="checkbox"/> <input type="checkbox"/>
OUTPUT AUDIO SETTINGS	1 2 3 4 5
INPUT AUDIO SETTINGS	RECALL PATTERN
EDID SETTINGS	OUT1 <input type="checkbox"/> <input type="checkbox"/> <input type="checkbox"/> <input type="checkbox"/> <input type="checkbox"/>
RS-232C SETTINGS	OUT2 <input type="checkbox"/> <input type="checkbox"/> <input type="checkbox"/> <input type="checkbox"/> <input type="checkbox"/>
LAN SETTINGS	1 2 3 4 5 6 7 8 9
CONTROL COMMAND	RECALL CROSSPOINT
USER PRESET	F1 F2 F3 F4 F5 F6 F7 F8 F9
BITMAP	FUNCTION <input type="checkbox"/> <input type="checkbox"/> <input type="checkbox"/> <input type="checkbox"/> <input type="checkbox"/> <input type="checkbox"/> <input type="checkbox"/> <input type="checkbox"/> <input type="checkbox"/>
POWER ON SETTINGS	BUTTON LOCK <input type="checkbox"/>
SYSTEM SETTINGS	<input checked="" type="checkbox"/> CHANNEL <input checked="" type="checkbox"/> MENU <input checked="" type="checkbox"/> F BUTTON <input checked="" type="checkbox"/> STANDBY <input checked="" type="checkbox"/> ALL
VIEW STATUS	NAME EDIT <input type="text"/>

Enabling WEB GUI login

Advanced

1. Select [MENU]→[SYSTEM SETTINGS].
2. Click the [LOGIN SETTING] button from [LOGIN SETTING] to open the [LOGIN] window.

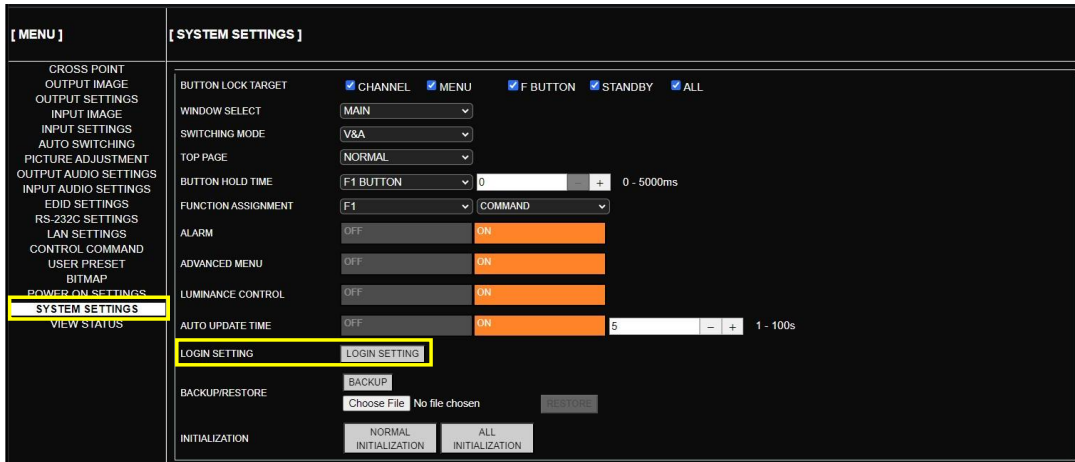

3. On the login page that appears next, enter the desired user ID and password.
 User ID : admin (Default)
 Password : admin (Default)
4. Click the [LOGIN] button.

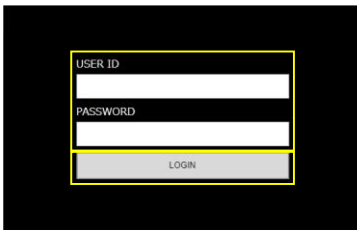

5. To change the user ID and password, enter the desired ID and password. (If you do not change them, you can skip this procedure.)

[NEW USER ID] : ASCII 30 to 39, 41 to 5A, 5F, 61 to 7A (0 to 9, A to Z, _, a to z)

[NEW PASSWORD] : ASCII 21 to 7D

[CONFIRM PASSWORD] : ASCII 21 to 7D

※Up to 24 characters

[LOGIN SETTING]

NEW USER ID

NEW PASSWORD SET

CONFIRM PASSWORD

LOGIN

Note

For the first-time setting, change the user ID and password.

6. Select [ON].

[LOGIN SETTING]

NEW USER ID

NEW PASSWORD SET

CONFIRM PASSWORD

LOGIN

7. The [LOGOUT] button appears at the upper right.

MSD-V42UC DIGITAL MULTI SWITCHER [LOGOUT]

[MENU] [SYSTEM SETTINGS]

CROSS POINT
OUTPUT IMAGE
OUTPUT SETTINGS
INPUT IMAGE
INPUT SETTINGS
AUTO SWITCHING
PICTURE ADJUSTMENT
OUTPUT AUDIO SETTINGS
INPUT AUDIO SETTINGS
EDID SETTINGS
RS-232C SETTINGS
LAN SETTINGS
CONTROL COMMAND
USER PRESET
BITMAP
POWER ON SETTINGS
SYSTEM SETTINGS
VIEW STATUS

BUTTON LOCK TARGET CHANNEL MENU F BUTTON STANDBY ALL

WINDOW SELECT MAIN

SWITCHING MODE V&A

TOP PAGE NORMAL

BUTTON HOLD TIME F1 BUTTON 0 0 - 5000ms

FUNCTION ASSIGNMENT F1 COMMAND

ALARM F1 ON

ADVANCED MENU F1 ON

LUMINANCE CONTROL F1 ON

AUTO UPDATE TIME F1 ON S 1 - 100s

LOGIN SETTING

BACKUP

BACKUP/RESTORE Choose File No file chosen

INITIALIZATION

Notes

- Multiple users cannot login at the same time. Only the last (subsequent) user can login.
- Once a user logs in, the session is kept until the user logs out or closes the browser.
- User ID and password are not saved to the backup file.
- Only if initialization command (@CLR,0) is initiated, the user ID and password are initialized.

Tip

Only basic menus are displayed by default. To display advanced menus as well, perform the procedure in “Advanced menu (P.20)”.

Logging into WEB GUI

If WEB GUI login is enabled, user ID and password need to be changed for WEB GUI operations.

1. Go to the WEB GUI login page.
2. On the login page that appears next, enter the user ID and password.
 User ID : admin (Default)
 Password : admin (Default)
3. Click the [LOGIN] button.

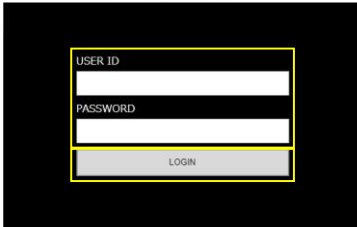

4. The [LOGOUT] button appears at the upper right.

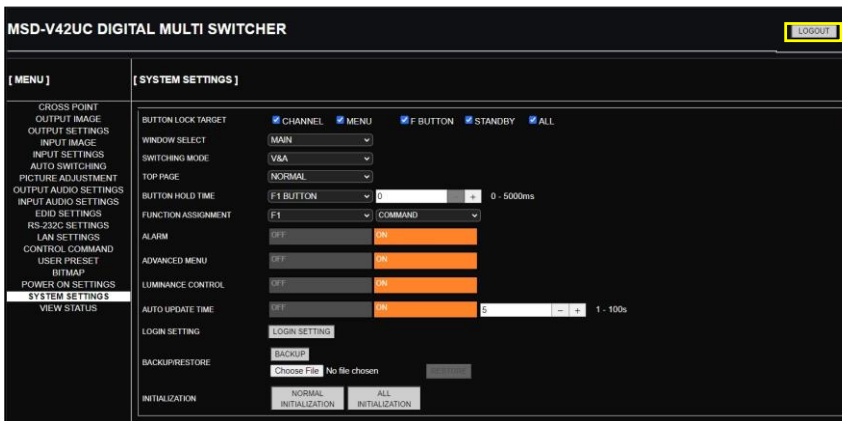

Logging out of WEB GUI

1. Click the [LOGOUT] button shown at upper right.

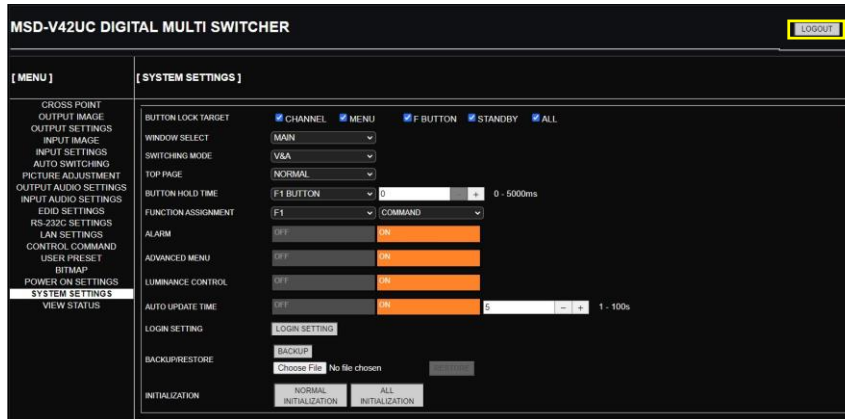

2. Click the [OK] button.



Setting Video Attributes

This section describes how to set input video and output video attributes, such as resolution, image size, image position, and so on.

Video signals are output in the following order:

Background color→Main window→Input video 1→PinP window→Input video 2

If a window size is reduced, the background image is displayed.

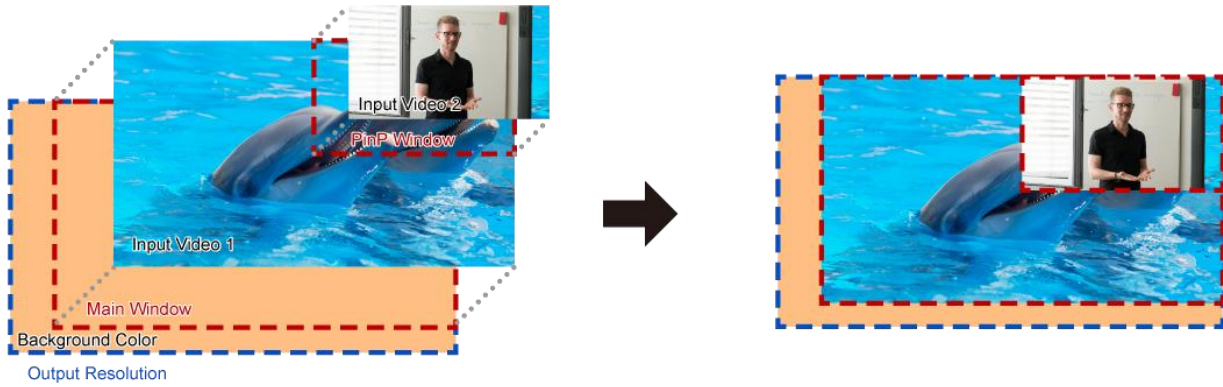

Changing output resolution

Automatically, the optimal output resolution format is delivered to the sink device upon connection and based on its EDID profile.

This section describes how to manually select output resolution formats.

Front Panel

1. Select [OUTPUT IMAGE]→[RESOLUTION].
2. Select the output.
3. Select the resolution. (Default: A (AUTO-A))
4. Press the MENU/ENTER button to accept the new value.

WEB GUI

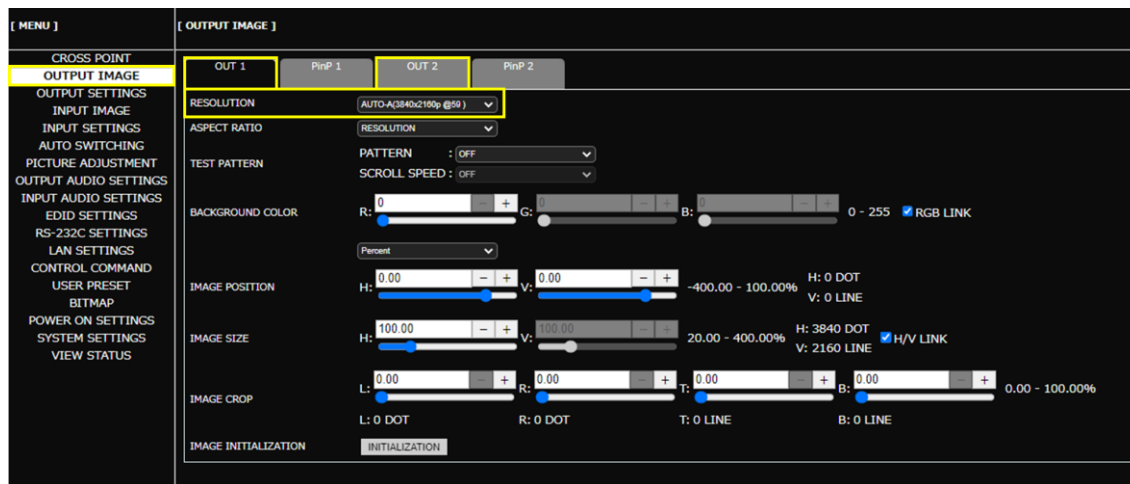

Note

The same single source is distributed to OUT A and OUT B at the same resolution. If sink devices having different resolution are connected to OUT A and OUT B, video may not be displayed on one of sink devices. In this case, change the resolution to the value that is supported by both sink devices to display video on both sink devices.

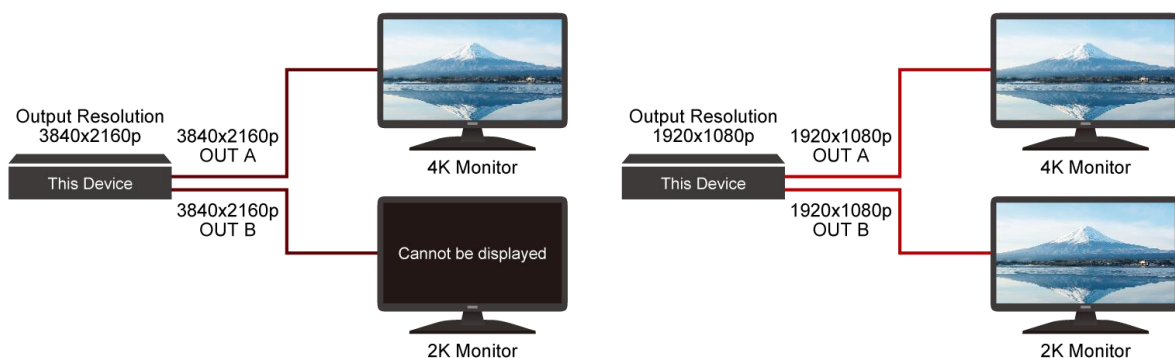

Adjusting image position

Front Panel

1. Select [OUTPUT IMAGE]→[IMAGE POSITION].
2. Select the window.
3. Set the desired values of [H] (Horizontal) or [V] (Vertical).
4. Set the image position. (Default: 0.0%)

WEB GUI



Adjusting image size

Front Panel

1. Select [OUTPUT IMAGE]→[IMAGE SIZE].
2. Select the output window.
3. Set the desired values of [HV] (Horizontal and vertical properly), [H] (Horizontal), or [V] (Vertical).
4. Set the image size. (Default: 100.0%)

WEB GUI

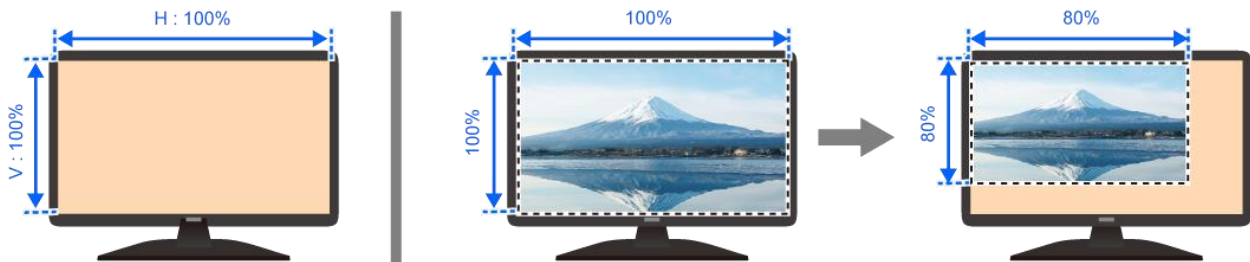
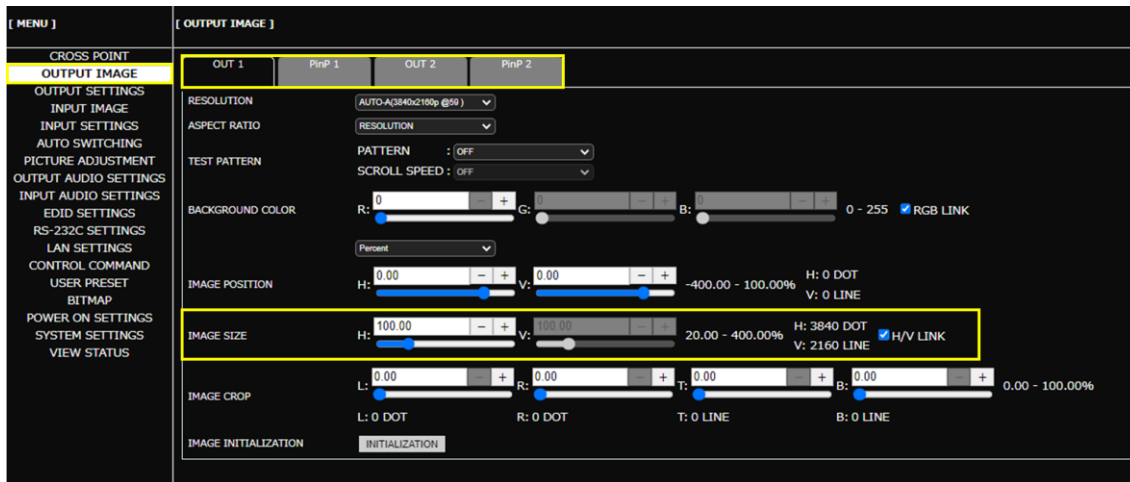

Displaying input video on full screen

The figures below show how a full input video is displayed on a full screen.

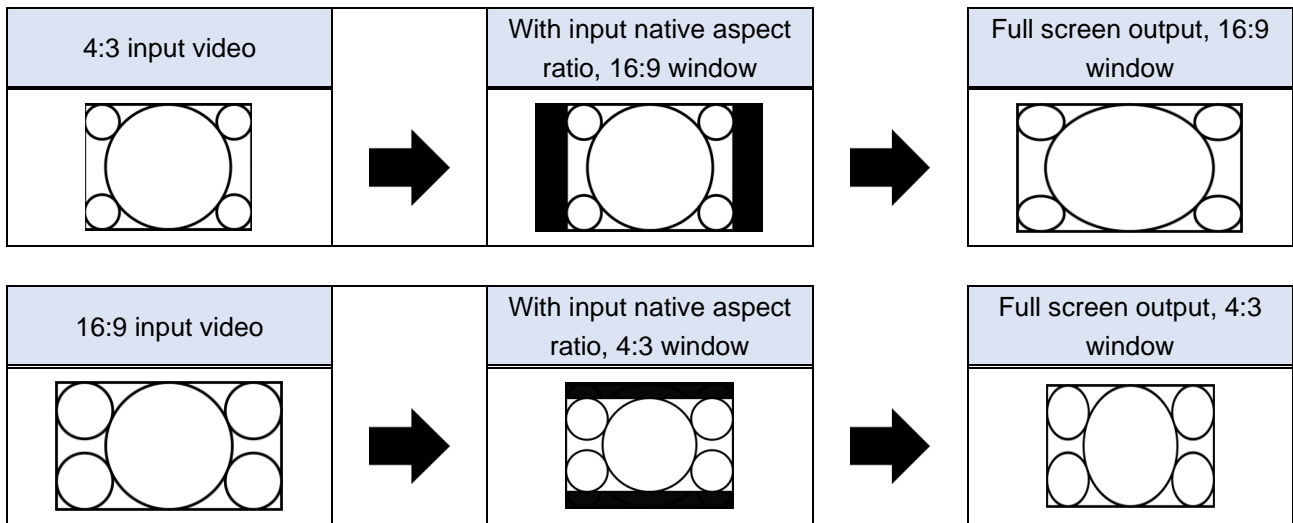

Displaying all input video on full screen

Advanced

Front Panel

1. Select [INPUT IMAGE]→[ASPECT RATIO].
2. Select the input.
3. Select [FULL]. (Default: AUTO-1)

WEB GUI



Tip

Only basic menus are displayed by default. To display advanced menus as well, perform the procedure in “Advanced menu (P.20)”.

Displaying all input video to desired output on full screen

Advanced

Front Panel

1. Select [OUTPUT IMAGE]→[ASPECT RATIO].
2. Select the output.
3. Select [FULL]. (Default: RESOLUTION)

WEB GUI

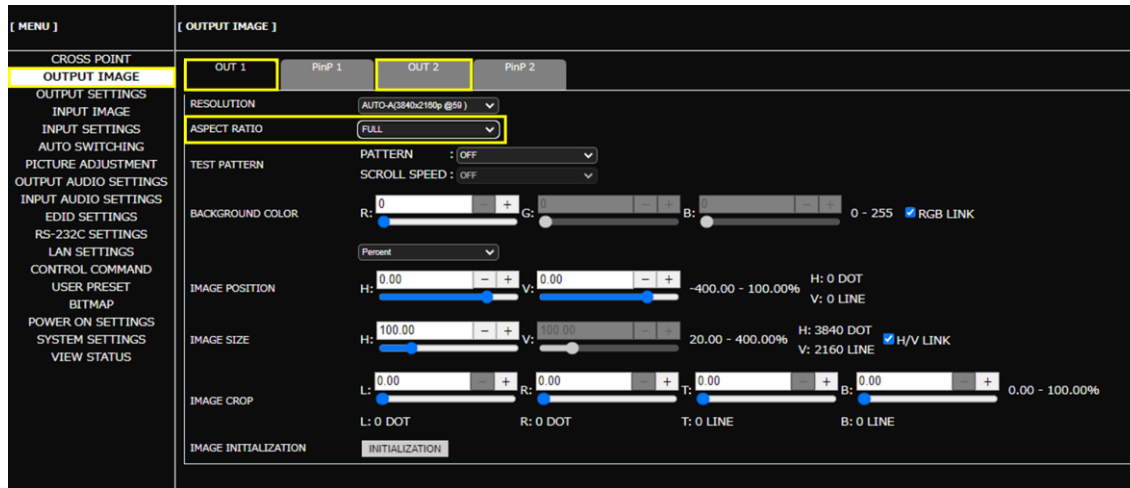

Tip

Only basic menus are displayed by default. To display advanced menus as well, perform the procedure in “**Advanced menu (P.20)**”.

Displaying input video dot-by-dot

Advanced

The figures below show how input video is displayed dot-by-dot.

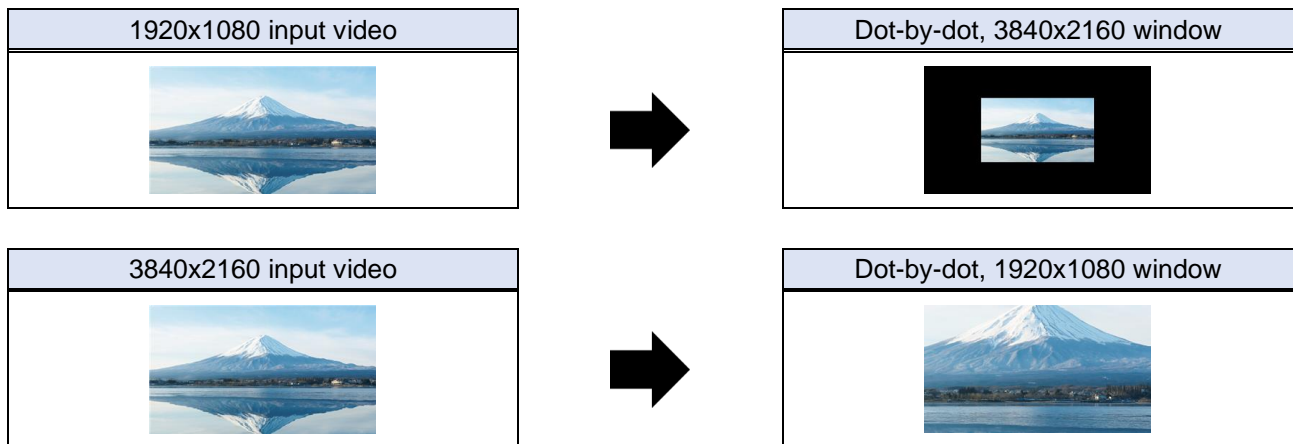

Front Panel

1. Select [INPUT IMAGE]→[ASPECT RATIO].
2. Select the input.
3. Select [THROUGH]. (Default: AUTO-1)

WEB GUI

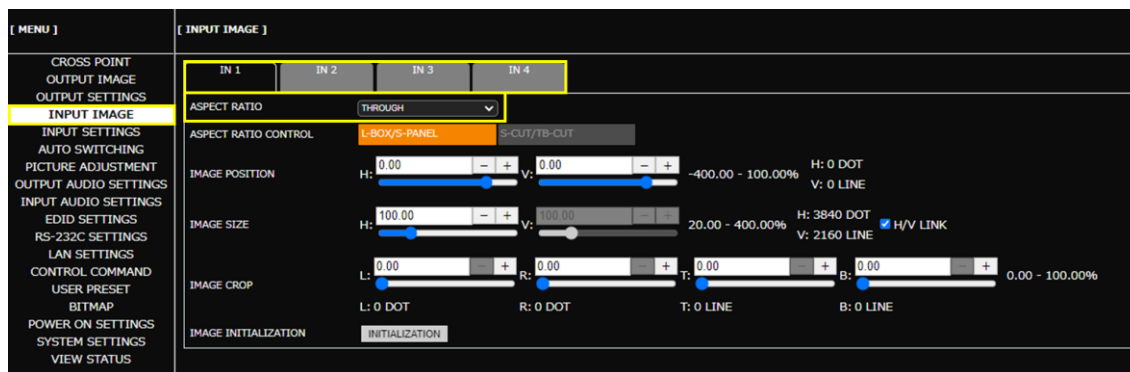

Tip

Only basic menus are displayed by default. To display advanced menus as well, perform the procedure in “Advanced menu (P.20)”.

Displaying video on non-HDCP compliant sink device

Advanced

By default, the MSD-V4 operates as an HDCP 2.2-compliant device.

If a source device that automatically determines and encrypts HDCP is connected, HDCP-encrypted video signals cannot be displayed on a non-HDCP compliant sink device.

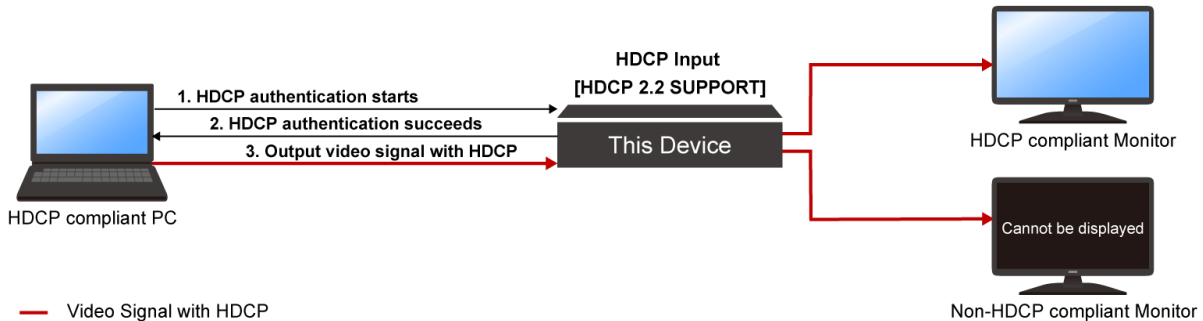

To display video signals on a non-HDCP compliant sink device, set the MSD-V4's input connector to Non-HDCP mode.

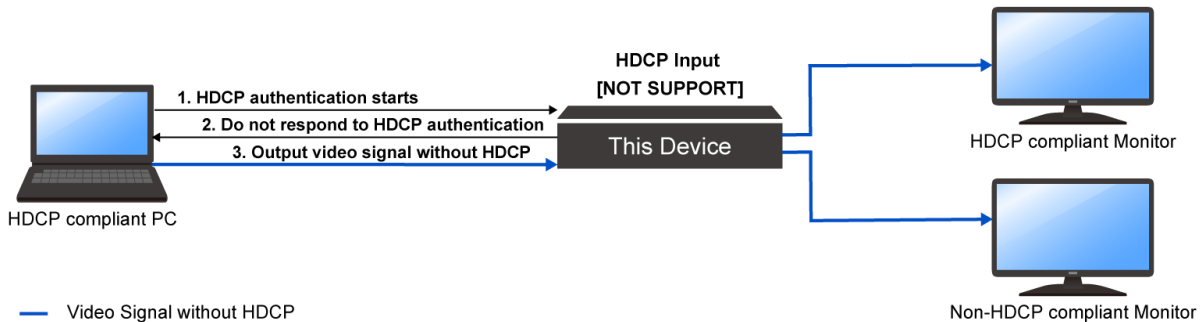

Front Panel

1. Select [INPUT SETTINGS]→[HDCP INPUT].
2. Select the input connector.
3. Select [NOT SUPPORT]. (Default: HDCP 2.2 SUPPORT)

WEB GUI

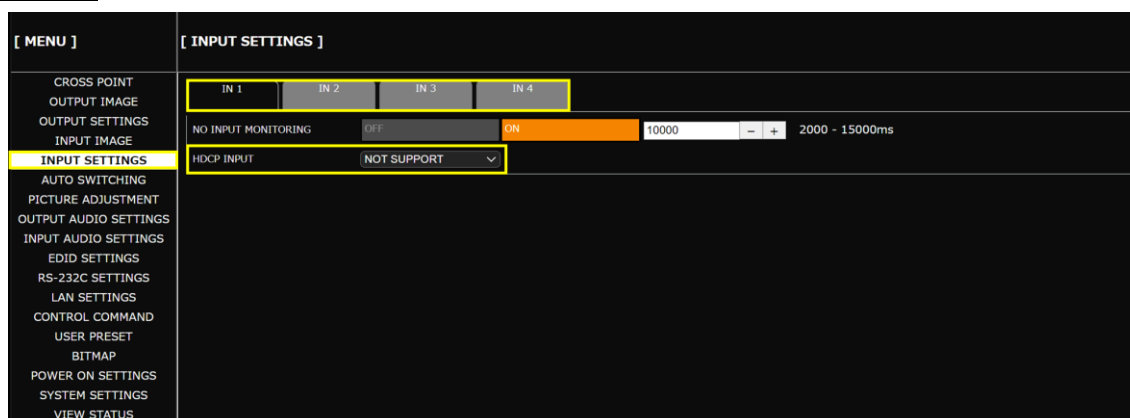

Note

For source devices that require HDCP encryption (for example, a Blu-ray player), video or audio cannot be presented on non-HDCP compliant sink devices.

Tip

Only basic menus are displayed by default. To display advanced menus as well, perform the procedure in “Advanced menu (P.20)”.

Enabling Deep Color input

Advanced

Front Panel

1. Select [EDID SETTINGS].
2. Set the input connector as follows:

Submenu	Setting value	Default
[EDID SELECTION]	BUILT-IN EDID	BUILT-IN EDID
[SIGNAL FORMAT]	HDMI	HDMI
[DEEP COLOR]	30-BIT COLOR	24-BIT COLOR

3. Press the MENU/ENTER button to accept the new values.

WEB GUI

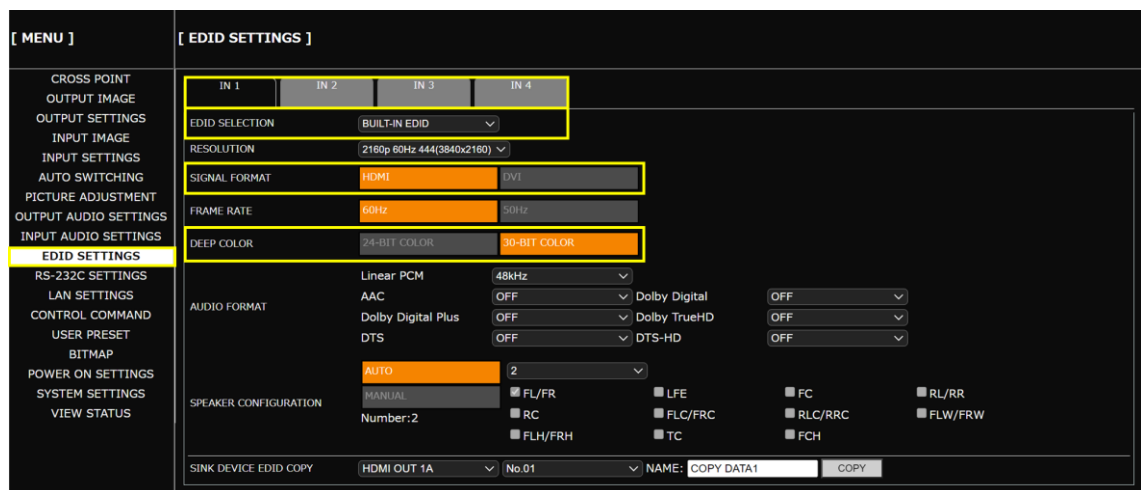

Tip

Only basic menus are displayed by default. To display advanced menus as well, perform the procedure in “Advanced menu (P.20)”.

Enabling Deep Color output

Advanced

Front Panel

1. Select [OUTPUT SETTINGS]→[DEEP COLOR].
2. Select the output connector.
3. Select [30-BIT COLOR]. (Default: 24-BIT COLOR)

WEB GUI

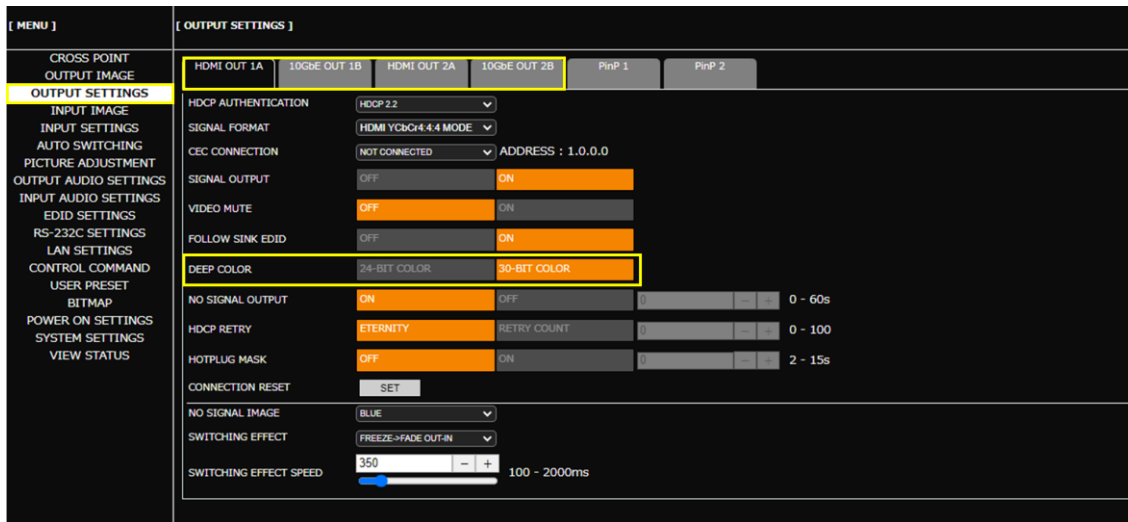

Notes

- Even with [30-BIT COLOR] selected, video signals are output at 24-BIT COLOR if the sink device does not support Deep Color.
- If [30-BIT COLOR] is selected and the output resolution is 4K@50/59.94/60, video signals are output at 30-BIT COLOR of HDMI YCbCr 4:2:2 or HDMI YCbCr 4:2:0.

Tip

Only basic menus are displayed by default. To display advanced menus as well, perform the procedure in **“Advanced menu (P.20)”**.

Outputting test patterns

Front Panel

1. Select [OUTPUT IMAGE]→[TEST PATTERN].
2. Select the output.
3. Select the test patten.
4. If the selected test pattern supports scrolling, select the scroll speed.

WEB GUI

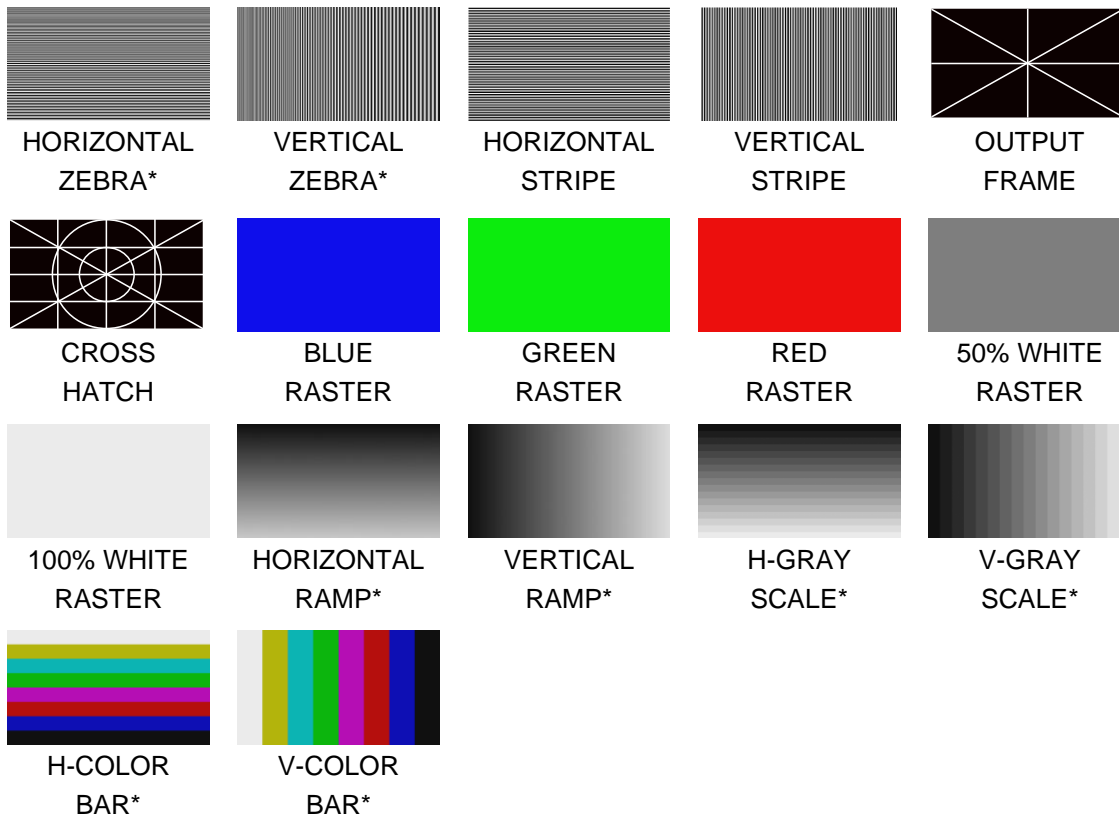
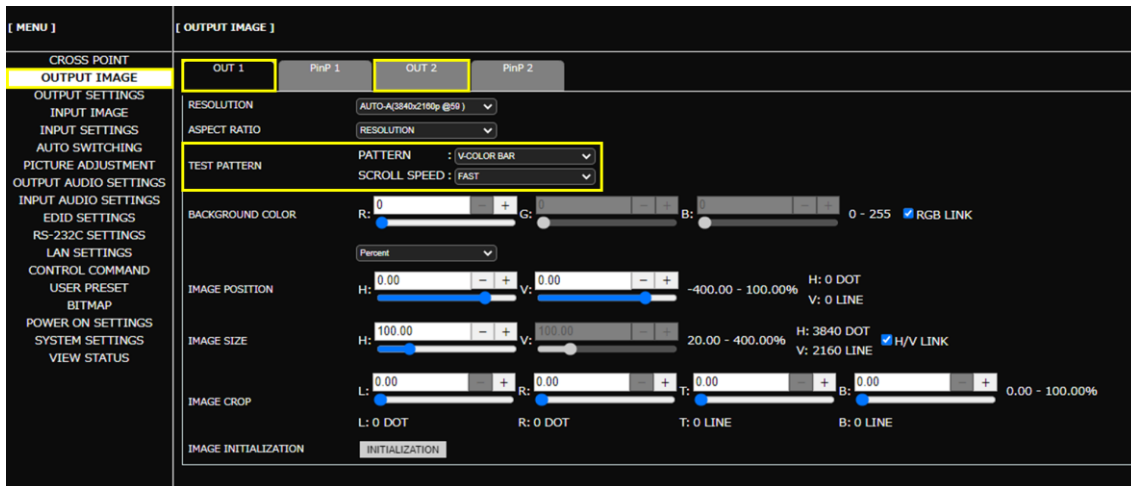

*Scrolling supported.

Setting Audio

This chapter describes how to configure and adjust input and output audio of the MSD-V4.

Digital input audio of an input channel is output from an HDMI output connector while de-embedded audio of HDMI output connector output signal is output from an analog audio output connector.

Adjusting Audio Level

1. Adjust the signal level differences between inputs audio:

Front Panel

- a) Select [INPUT AUDIO SETTINGS]→[AUDIO LEVEL].
- b) Select the input connector.
- c) Set the input audio level. (Default: 0dB)

WEB GUI



2. Adjust the audio level for each output audio:

Front Panel

- a) Select [OUTPUT AUDIO SETTINGS]→[AUDIO LEVEL].
- b) Select the output connector.
- c) Set the output audio level. (Default: 0dB)

WEB GUI

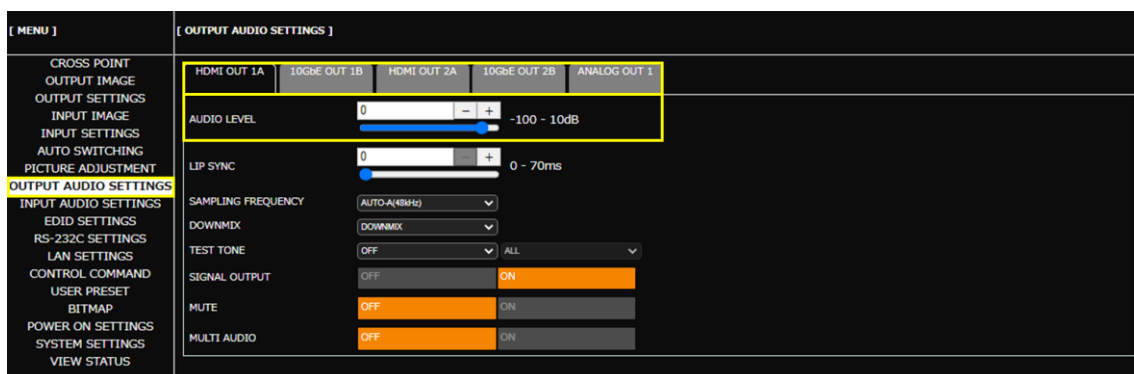

Embedding analog input audio

Analog audio can be embedded to a desired input video.

Front Panel

1. Select [INPUT AUDIO SETTINGS]→[SOURCE SELECTION].
2. Select the input.
3. Select [ANALOG1]. (Default: DIGITAL)
4. Press the BACK button until the MENU/ENTER button LED lights green.
5. Press the selected input selection button.

WEB GUI

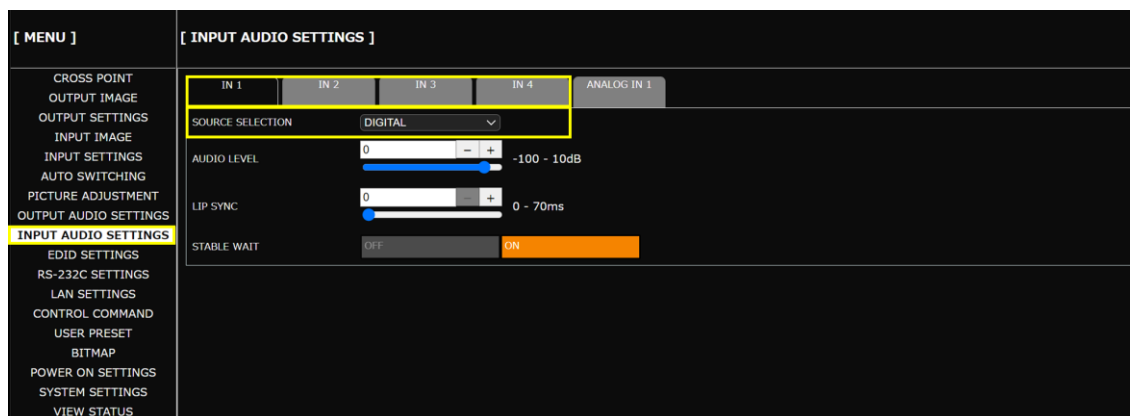

De-embedding audio

Advanced

By default, OUT1's input audio is de-embedded and output from the analog audio output connector.

Front Panel

1. Select [OUTPUT AUDIO SETTINGS]→[ANALOG OUTPUT].
2. Select the digital output whose audio is de-embedded and output to the analog audio output connector.

WEB GUI

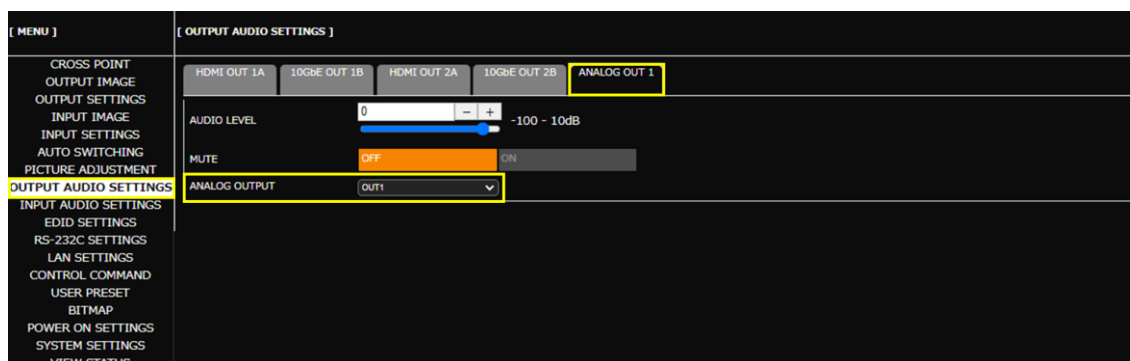

Tip

Only basic menus are displayed by default. To display advanced menus as well, perform the procedure in "Advanced menu (P.20)".

Enabling multichannel audio input

Advanced

By default, it is set to 2-channel audio so that multichannel audio is not output from a source device. If you want to input multichannel audio, change the EDID settings.

Front Panel

1. Select [EDID SETTINGS].
2. Set the input connector as follows:

Submenu	Setting value	Default
[EDID SELECTION]	BUILT-IN EDID	BUILT-IN EDID
[SIGNAL FORMAT]	HDMI	HDMI
[SPEAKER CONFIGURATION]	AUTO	AUTO
	3 to 8 (Number of speakers)	2

3. Press the MENU/ENTER button to accept the new values.

WEB GUI

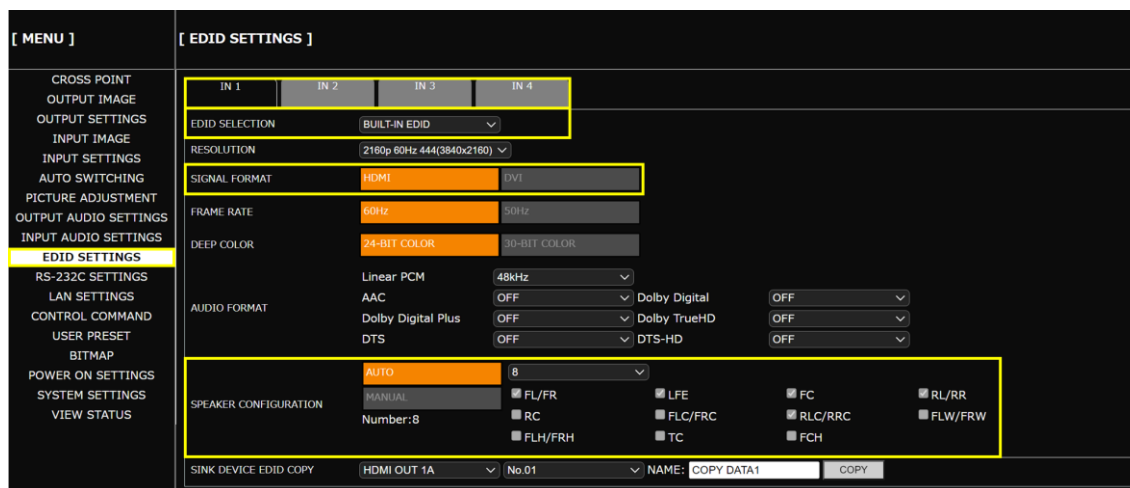

Tips

- To select speakers for multichannel audio manually, set [SPEAKER CONFIGURATION] to [MANUAL].

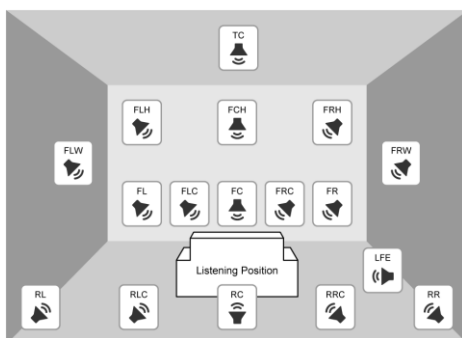

FL : Front Left	RRC : Rear Right Center
FC : Front Center	LFE : Low Frequency Effect
FR : Front Right	FLW : Front Left Wide
FLC : Front Left Center	FRW : Front Right Wide
FRC : Front Right Center	FLH : Front Left High
RL : Rear Left	FCH : Front Center High
RC : Rear Center	FRH : Front Right High
RR : Rear Right	TC : Top Center
RLC : Rear Left Center	

- Only basic menus are displayed by default. To display advanced menus as well, perform the procedure in “Advanced menu (P.20)”.

Enabling multichannel audio output

Advanced

By default, downmixed audio is output if multichannel audio is applied to an input. If you want to output multichannel audio, change the setting as follows:

Front Panel

1. Select [OUTPUT AUDIO SETTINGS]→[MULTI AUDIO].
2. Select the output connector.
3. Select [ON]. (Default: OFF)

WEB GUI

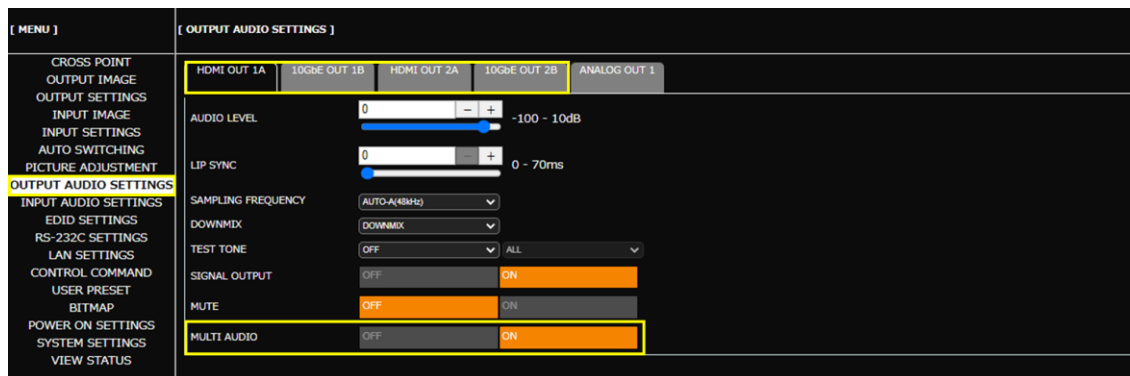

Note

Without downmixing, if the sink device does not support multichannel audio, only part of the audio program is presented.

Tip

Only basic menus are displayed by default. To display advanced menus as well, perform the procedure in “**Advanced menu (P.20)**”.

Downmixing multichannel LPCM input audio

Advanced

To downmix multichannel LPCM input audio, set the digital audio and analog audio downmix.

Front Panel

1. Select [OUTPUT AUDIO SETTINGS]→[MULTI AUDIO].
2. Select the output connector.
3. Select [OFF]. (Default: OFF)
4. Select [OUTPUT AUDIO SETTINGS]→[DOWNMIX].
5. Select the output connector.
6. Select [DOWNMIX]. (Default: DOWNMIX)

WEB GUI

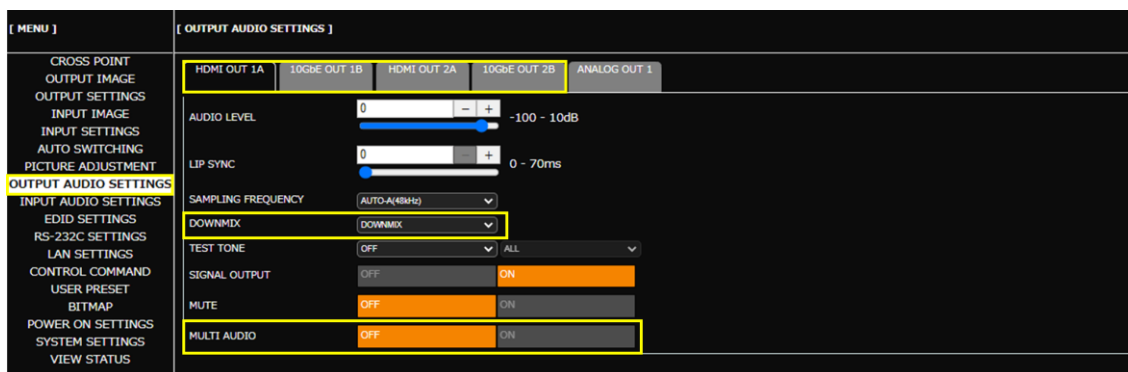

Tip

Only basic menus are displayed by default. To display advanced menus as well, perform the procedure in “Advanced menu (P.20)”.

Enabling Bitstream audio

Advanced

By default, multichannel audio is not output from a source device. Change the EDID settings to enable Bitstream audio.

Front Panel

1. Select [EDID SETTINGS].
2. Set the input connector as follows:

Submenu	Setting value	Default
[EDID SELECTION]	BUILT-IN EDID	BUILT-IN EDID
[SIGNAL FORMAT]	HDMI	HDMI
[SPEAKER CONFIGURATION]	AUTO	AUTO
	3 to 8 (Number of speakers)	2

3. Press the MENU/ENTER button.
4. Select the audio format.
5. Select the input connector.
6. Select the sampling frequency. (Default: OFF)
7. Press the MENU/ENTER button to accept the new value.

WEB GUI

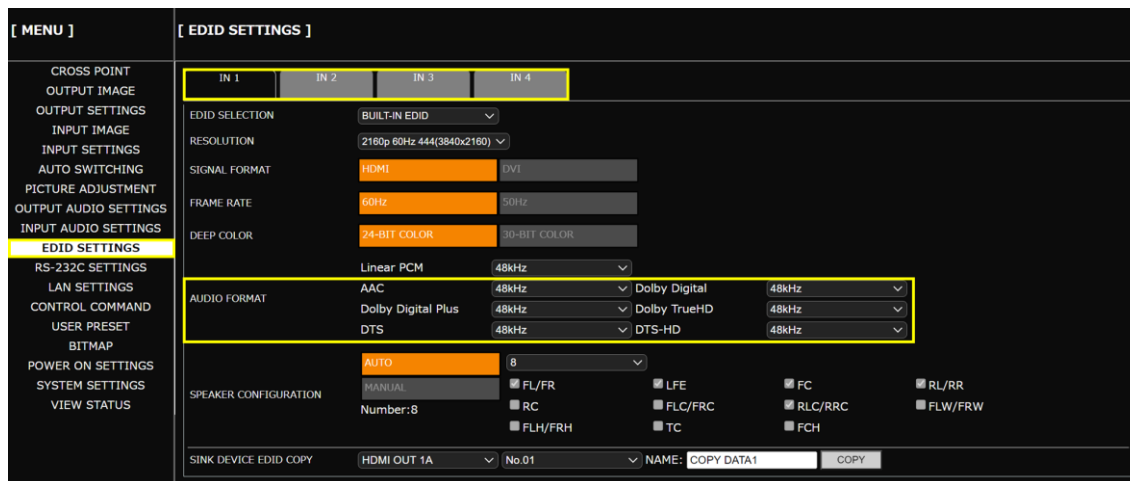

Notes

- The following Bitstream audio are supported: AAC, Dolby Digital, Dolby Digital Plus, Dolby TrueHD, DTS, and DTS-HD
- Bitstream audio that is not supported by the sink device cannot be output.
- If Bitstream audio is input or output, audio settings are disabled and analog audio cannot be output.

Tip

Only basic menus are displayed by default. To display advanced menus as well, perform the procedure in “Advanced menu (P.20)”.

Outputting test tone

The test tone feature is useful for checking audio output operation, to confirm multichannel speaker assignment and to perform audio level adjustment.

Front Panel

1. Select [OUTPUT AUDIO SETTINGS]→[TEST TONE].
2. Select the output connector.
3. Select the test tone frequency.
4. Select the speaker.

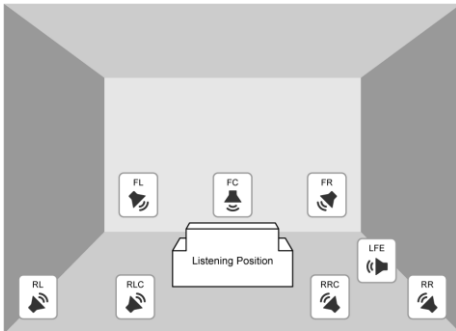

FL : Front Left
 FC : Front Center
 FR : Front Right
 LFE : Low Frequency Effect
 RL : Rear Left
 RLC : Rear Left Center
 RRC : Rear Right Center
 RR : Rear Right

WEB GUI

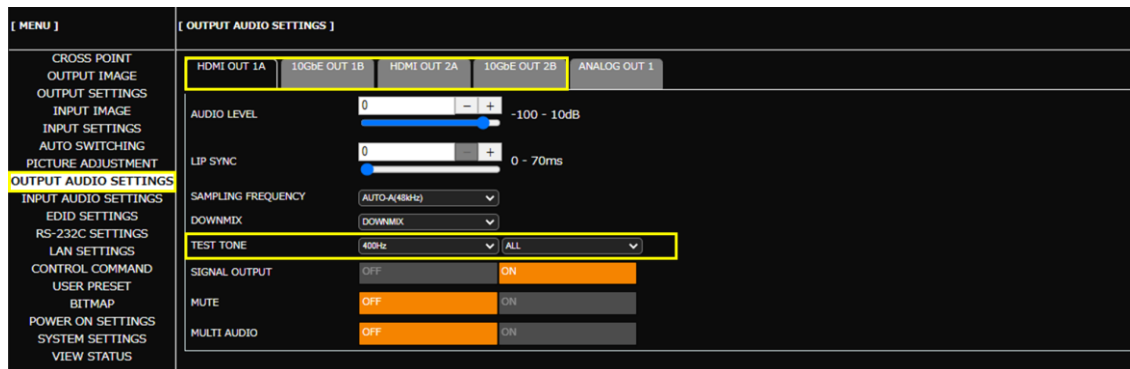

EDID

This chapter describes how to select EDID options and change EDID settings.

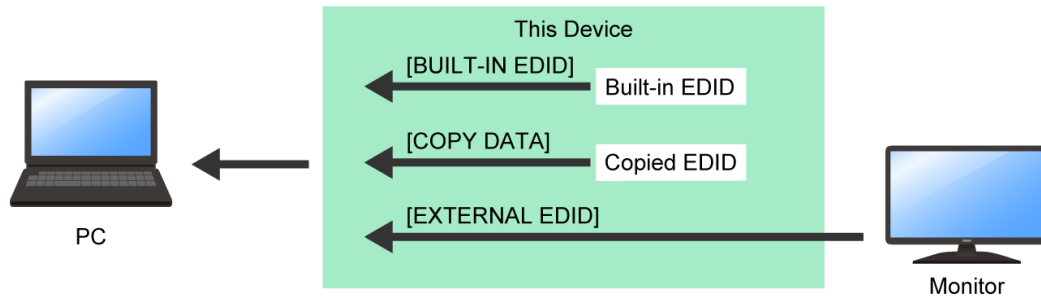

[BUILT-IN EDID] : MSD-V4's EDID. Native resolution and the like can be changed.

[COPY DATA] : EDID copied from sink devices.

[EXTERNAL EDID] : EDID of sink devices connected to output connectors.

Selecting EDID

Front Panel

1. Select [EDID SETTINGS]→[EDID SELECTION].
2. Select the input connector.
3. Select the EDID profile. (Default: BUILT-IN EDID)
4. Press the MENU/ENTER button to accept the new value.

WEB GUI

Note

[COPY DATA] can be selected only if valid stored data is available. Names that are set at the time of storing are displayed. For how to store the copied data to the MSD-V4, see “**Copying EDID of sink device (P.54)**”.

Changing supported resolution of built-in EDID

Front Panel

1. Select [EDID SETTINGS]→[RESOLUTION].
2. Select the input connector.
3. Select the resolution format. (Default: 3840x2160@60Hz 4:4:4)
4. Press the MENU/ENTER button to accept the new value.

WEB GUI

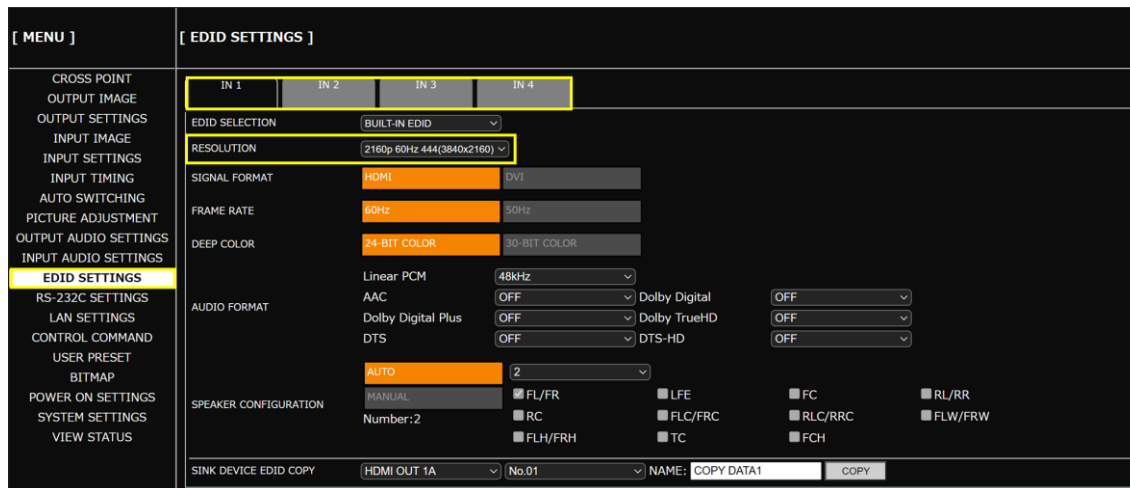

Note

If a source device that does not support 4K is connected when the MSD-V4's EDID is set to 4K, video may not be output correctly. Change the EDID settings according to the format supported by the source device.

Copying EDID of sink device

Front Panel

1. Select [EDID SETTINGS]→[SINK DEVICE EDID COPY].
2. Select the output connector to which the sink device is connected.
3. Select the memory location number.
4. Enter the desired name.
5. Press the MENU/ENTER button to accept the new values.

WEB GUI

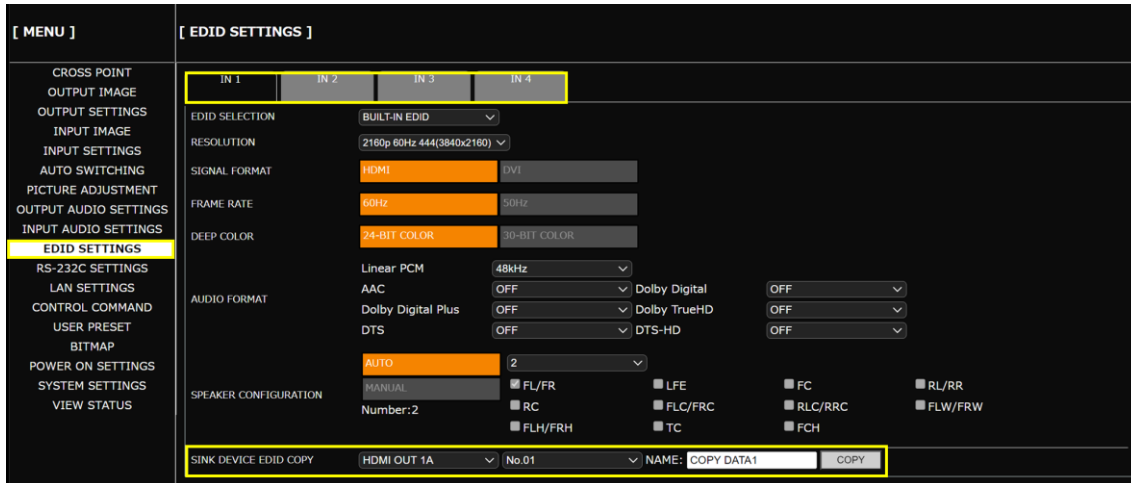

Picture in Picture

This chapter describes how to set up overlapping windows.



PinP

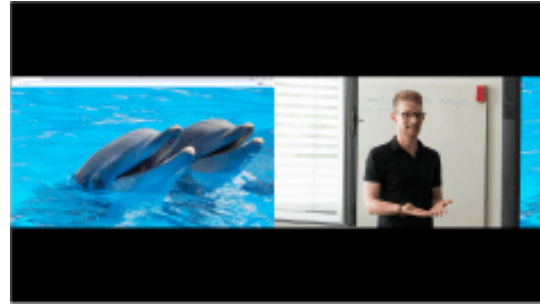

Side by Side

PinP window video can be switched separately. The window layout is switched by recalling a pattern memory. The following information is stored to the pattern memory.

- Enabling/Disabling PinP window display.
- Image positions and dimensions of the main window and PinP window

Displaying PinP window

Front Panel

1. Select [OUTPUT IMAGE]→[PinP OUTPUT].
2. Select the output.
3. Select [ON].

WEB GUI

The screenshot shows the WEB GUI interface for the CROSS POINT section. The left sidebar contains a menu with the following items: CROSS POINT, OUTPUT IMAGE, OUTPUT SETTINGS, INPUT IMAGE, INPUT SETTINGS, AUTO SWITCHING, PICTURE ADJUSTMENT, OUTPUT AUDIO SETTINGS, INPUT AUDIO SETTINGS, EDID SETTINGS, RS-232C SETTINGS, LAN SETTINGS, CONTROL COMMAND, USER PRESET, BITMAP, POWER ON SETTINGS, SYSTEM SETTINGS, and VIEW STATUS. The main panel displays various settings and controls:

- STANDBY MODE:** A green indicator light.
- SWITCHING MODE:** V&A, VIDEO, and AUDIO buttons.
- CHANNEL SELECT:** A grid of buttons for IN1, IN2, IN3, IN4, OFF, and PinP ON. The PinP ON button is highlighted with a yellow box.
- RECALL PATTERN:** Buttons for OUT1 and OUT2, numbered 1 to 5.
- RECALL CROSSPOINT:** Buttons numbered 1 to 9.
- FUNCTION:** Buttons labeled F1 through F9.
- BUTTON LOCK:** A section with checkboxes for LOCK, CHANNEL, MENU, F BUTTON, STANDBY, and ALL.
- NAME EDIT:** A text input field labeled NAME EDIT.

Switching PinP video

Front Panel

1. Select [SYSTEM SETTINGS]→[WINDOW SELECT].
2. Select [PinP]. (Default: MAIN)
3. Press the BACK button until the MENU/ENTER button LED lights green.
4. Press the input selection button.

Tip

Video of the main window and PinP window can be switched by assigning [WINDOW SELECT] to a user programmable function button as follows. For details, see “**Setting function button mode (P.24)**”.

If the assigned function button lights solid green, the PinP window video is switched by pressing the input selection button.

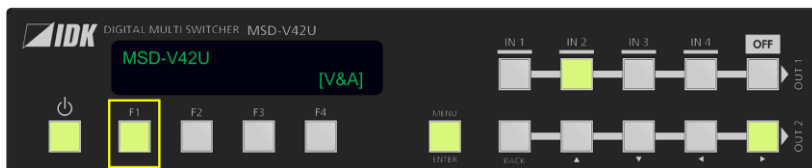

If the assigned function button lights solid amber, the main window video is switched by pressing the input selection button.

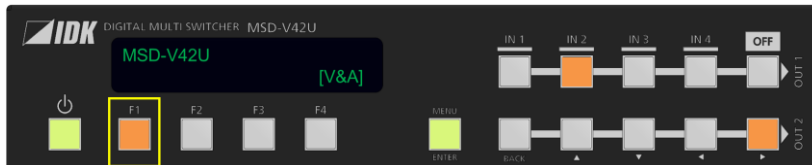

WEB GUI

The screenshot displays the [CROSS POINT] menu in the WEB GUI. The left sidebar contains a list of menu items, with [CROSS POINT] highlighted. The main content area is divided into several sections:

- STANDBY MODE:** A green indicator light is shown.
- SWITCHING MODE:** Three buttons labeled V&A, VIDEO, and AUDIO are visible.
- CHANNEL SELECT:** A grid of buttons for OUT1 and OUT2. Each output has a MAIN button and a PinP button. The PinP buttons for OUT1 and OUT2 are highlighted with a yellow box. A red indicator light is shown to the right of the PinP buttons.
- RECALL PATTERN:** A grid of buttons for OUT1 and OUT2, numbered 1 through 5.
- RECALL CROSSPOINT:** A grid of buttons numbered 1 through 9.
- FUNCTION:** A row of buttons labeled F1 through F9.
- BUTTON LOCK:** A section with a lock icon and five checked checkboxes: CHANNEL, MENU, F BUTTON, STANDBY, and ALL.
- NAME EDIT:** A text input field labeled NAME EDIT.

Note

For PinP window, only video is switched regardless of the [SWITCHING MODE] setting.

Switching window layout

By default, the following window layouts are stored to the pattern memory.

No.1



Main window only

No.2



PinP window is displayed.
(Upper-left)

No.3



PinP window is displayed.
(Upper-right)

No.4



PinP window is displayed.
(Lower-right)

No.5

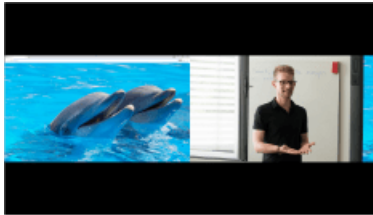

PinP window is displayed.
(Side-by-Side)

Front Panel

1. Select [USER PRESET]→[RECALL PATTERN].
2. Select the output.
3. Select the pattern memory location number.
4. Press the MENU/ENTER button.
The confirmation message appears.
5. Select [YES].
6. Press the MENU/ENTER button to accept the new value.

Tips

- Layouts can be recalled in the order of pattern memory location number by assigning [RECALL PATTERN] to a function button. For the procedure, see “**Setting function button mode (P.24)**”.
- For the procedure for changing layouts, see “**Adjusting image position (P.36)**” and “**Adjusting image size (P.37)**”.
- For the procedure for storing layouts, see “**Storing layouts in pattern memory (P.89)**”.

WEB GUI

[MENU] [CROSS POINT]

CROSS POINT

OUTPUT IMAGE

OUTPUT SETTINGS

INPUT IMAGE

INPUT SETTINGS

AUTO SWITCHING

PICTURE ADJUSTMENT

OUTPUT AUDIO SETTINGS

INPUT AUDIO SETTINGS

EDID SETTINGS

RS-232C SETTINGS

LAN SETTINGS

CONTROL COMMAND

USER PRESET

BITMAP

POWER ON SETTINGS

SYSTEM SETTINGS

VIEW STATUS

STANDBY MODE

V&A VIDEO AUDIO

SWITCHING MODE

IN1 IN2 IN3 IN4 OFF PinP ON

CHANNEL SELECT

OUT1 MAIN

PinP

OUT2 MAIN

PinP

RECALL PATTERN

OUT1 1 2 3 4 5

OUT2 1 2 3 4 5

RECALL CROSSPOINT

1 2 3 4 5 6 7 8 9

FUNCTION

F1 F2 F3 F4 F5 F6 F7 F8 F9

BUTTON LOCK

BUTTON LOCK CHANNEL MENU F BUTTON STANDBY ALL

NAME EDIT

Tip

Input selection information is not stored to pattern memories. To switch a window layout and input selection simultaneously, recall the crosspoint memory at the same time or recall the preset memory. For details, see “**Storing and Recalling Presets (P.85)**”.

Bitmap

This chapter describes how to store and display bitmap files.

To store bitmap files, the MSD-V4 supports DIB (Device Independent Bitmap) with a header generally used for Windows. These files need to meet the following requirements:

- File header : BITMAPFILEHEADER
- Information header : BITMAPCOREHEADER (for OS/2), BITMAPINFOHEADER (for Windows)
- The number of colors : 2 colors (monochrome, 1 bit), 16 colors (4 bits), 256 colors (8 bits),
16.77 million colors (TRUE COLOR, 24 bits)
- Size of an image: : [MEMORY MODE] [2K (4 BITMAPS)] : 2048x1152 or smaller
[MEMORY MODE] [4K (1 BITMAP)] : 4096x2160 or smaller
- Compression format : No compression (BI_RGB), 8 bit-run-length compression (BI_RLE8),
4 bit-run-length compression (BI_RLE4)

Storing bitmap file

Advanced

WEB GUI

1. Select [MENU]→[BITMAP].
2. Select a maximum resolution for [MEMORY MODE].
 - 2K (4 BITMAPS) : Up to four bitmap files of 2048x1152 or smaller.
 - 4K (1 BITMAP) : One bitmap file of 4096x2160 or smaller
3. Click [SET].

Notes

- Once the setting is changed, stored bitmap files are deleted automatically.
 - Approximate upload times for bitmap images is six minutes for 1920x1080 and 20 minutes for 3840x2160.
4. Select the bitmap file number from the [SEND BITMAP] drop-down menu.
 5. Click [Choose File] and select the bitmap file.
 6. Click [SEND].

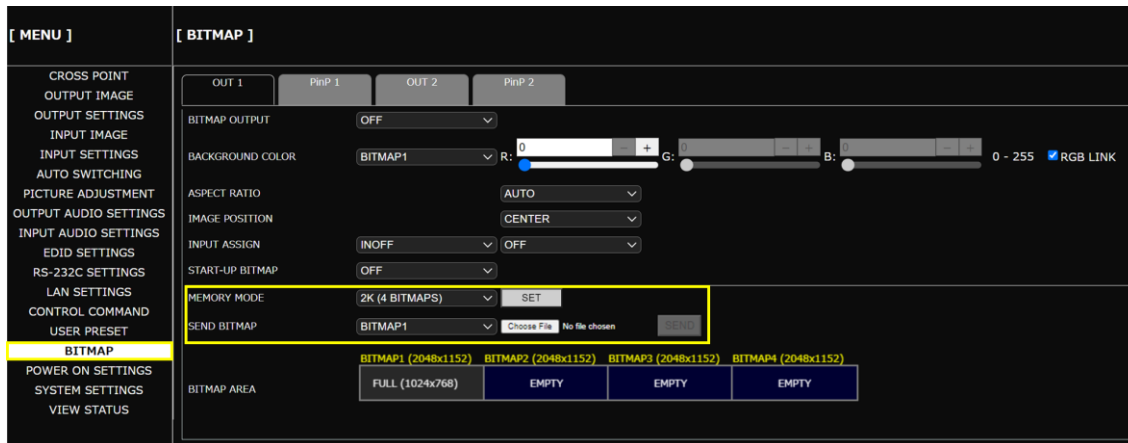

Notes

- Do not power off the MSD-V4 while the message, [Writing Bitmap Please Wait...] appears on the front panel display. The settings may be deleted.
- The stored bitmap file is not deleted even after initialization or it cannot be backed up.
- Use a WEB browser to store bitmap files. Bitmap files cannot be stored via the front panel.

Tip

Only basic menus are displayed by default. To display advanced menus as well, perform the procedure in “Advanced menu (P.20)”.

Displaying a bitmap

Front Panel

1. Select [BITMAP]→[BITMAP OUTPUT].
2. Select the window.
3. Select the stored bitmap file number.

WEB GUI

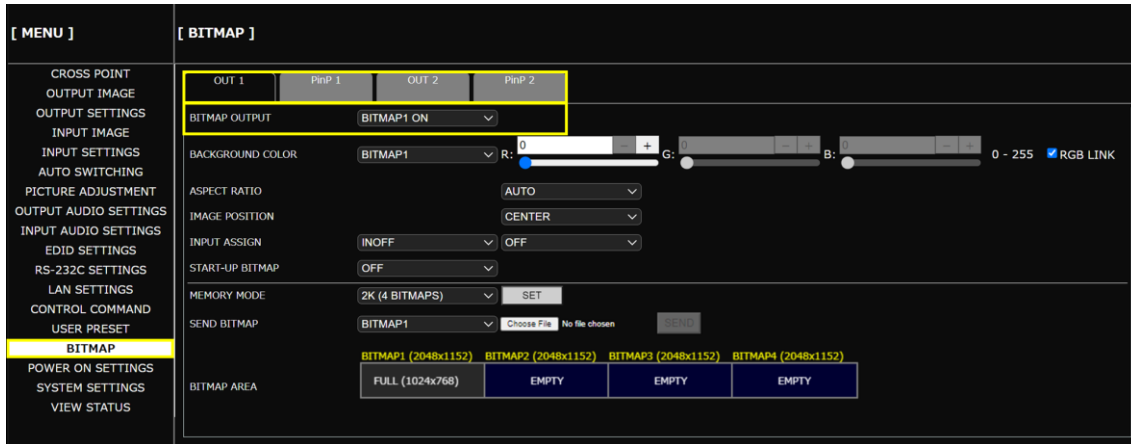

Note

Only numbers corresponding to stored bitmap files can be selected.

Displaying bitmap when an input is set to OFF

Advanced

Front Panel

1. Select [BITMAP]→[INPUT ASSIGN].
2. Select the window.
3. Select [INOFF] for [INPUT ASSIGN].
4. Select the bitmap file number.
5. Press the MENU/ENTER button to accept the new value.

WEB GUI

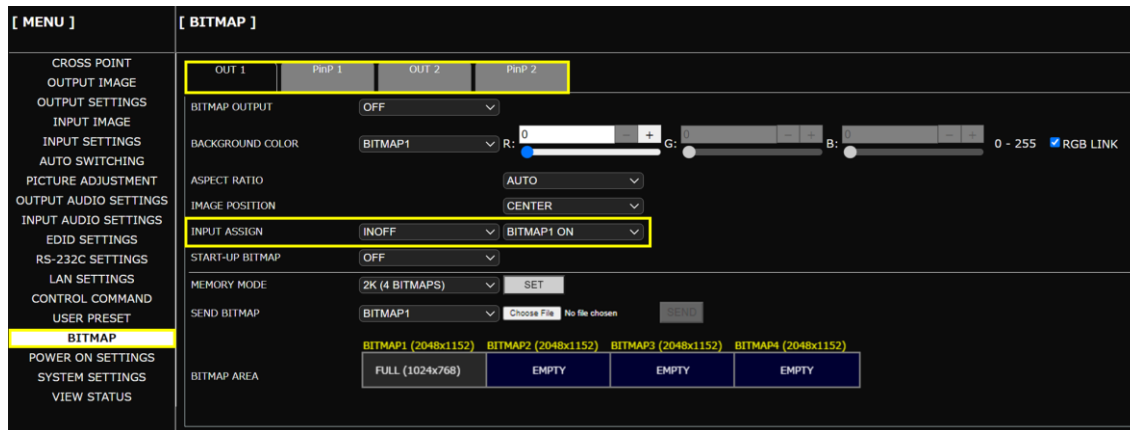

Note

Only numbers corresponding to stored bitmap files can be selected.

Tip

Only basic menus are displayed by default. To display advanced menus as well, perform the procedure in “Advanced menu (P.20)”.

Displaying bitmap when no video signal is present at input

Advanced

Front Panel

1. Select [OUTPUT SETTINGS]→[NO SIGNAL IMAGE].
2. Select the window.
3. Select the bitmap file number.

WEB GUI

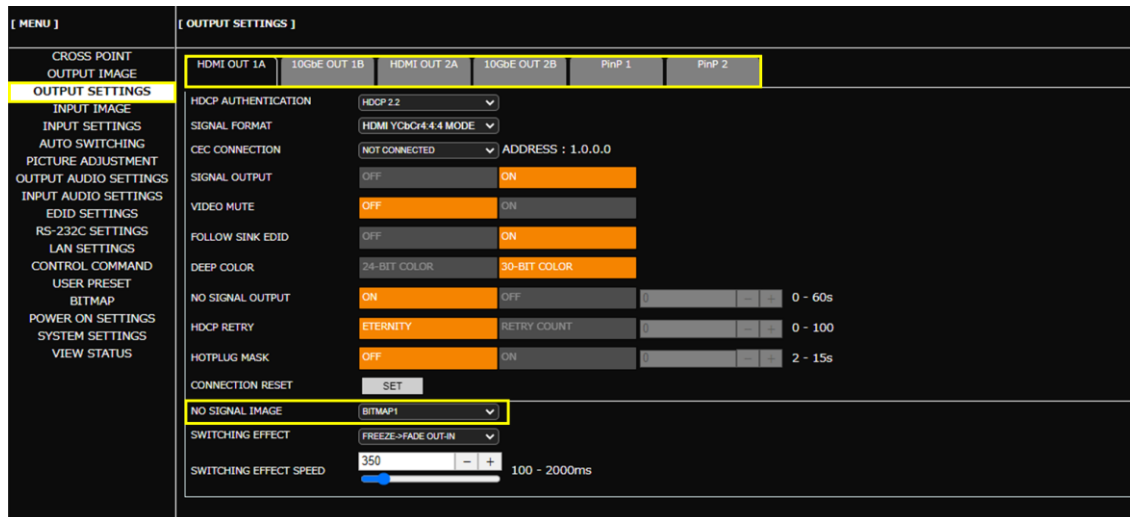

Note

Only numbers corresponding to stored bitmap files can be selected.

Tip

Only basic menus are displayed by default. To display advanced menus as well, perform the procedure in “Advanced menu (P.20)”.

Automatic Input Switching

This chapter describes how to automatically select connected inputs based on detection of video signal activity.

Configuring automatic input switching

Advanced

The example below shows how to set automatic channel switching for when video signal input is detected and when input video signal disappears.

- Setting automatic switching to the channel in which input video signal is detected:

Front Panel

- Select [AUTO SWITCHING]→[SIGNAL ON PRIORITY].
- Select the window.
- Select the same priority for all inputs.
- Press the MENU/ENTER button.

WEB GUI

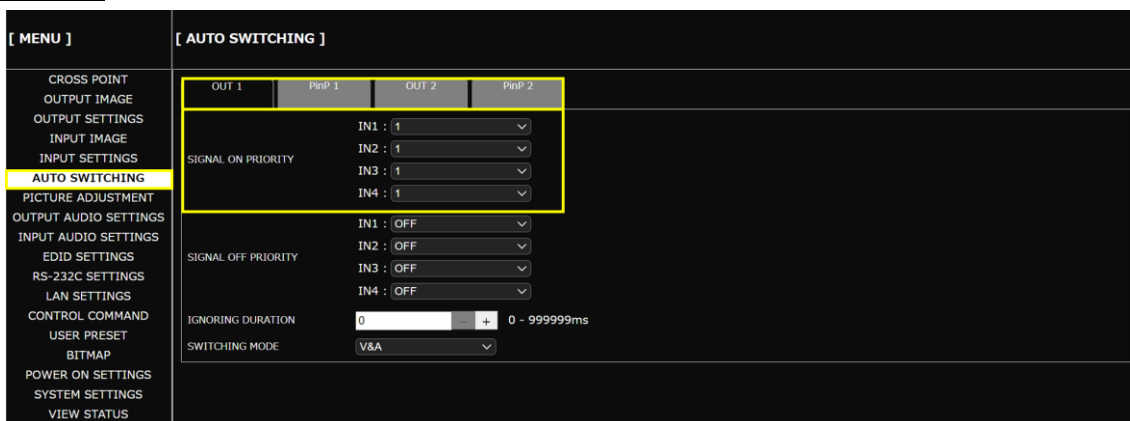

2. Setting automatic switching to IN1 for when input video signal disappears:

Front Panel

- a) Select [AUTO SWITCHING]→[SIGNAL OFF PRIORITY].
- b) Select the window.
- c) Select the priorities as follows:

Input	Setting value	Description
[IN1]	1	The top priority
Inputs other than IN1	OFF	No priority is set.

- d) Press the MENU/ENTER button to accept the new values.

WEB GUI

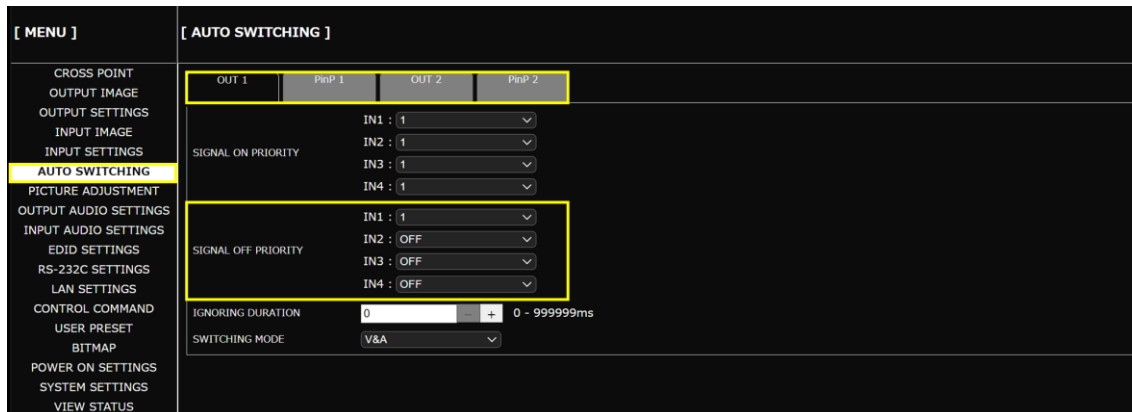

3. Selecting signal to be switched:

Front Panel

- a) Select [AUTO SWITCHING]→[SWITCHING MODE].
- b) Select the window.
- c) Select [V&A].

WEB GUI

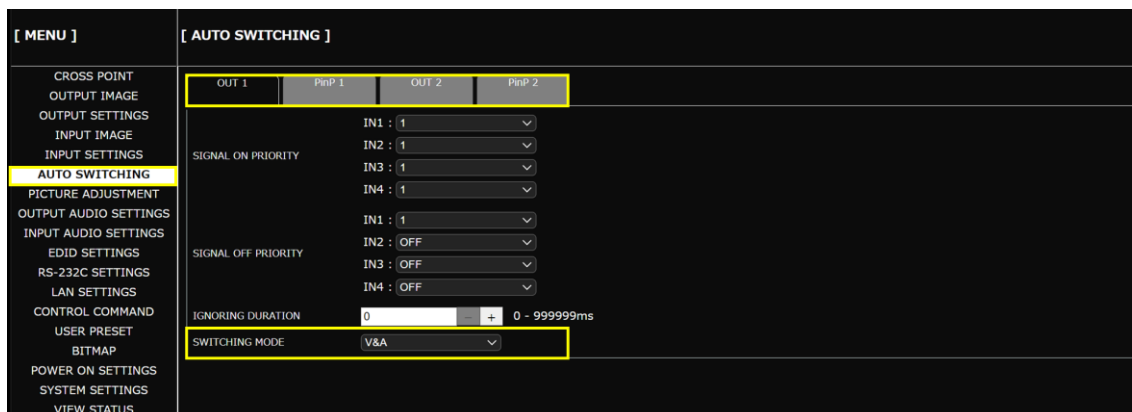

Tip

Only basic menus are displayed by default. To display advanced menus as well, perform the procedure in “Advanced menu (P.20)”.

Automatic input switching – Setting response delay interval

Advanced

If changes in input video signals are detected at short intervals, inputs are switched automatically and continuously. This successive automatic switching can be avoided by setting the change detection interval manually after the auto-input switching is executed.

Front Panel

1. Select [AUTO SWITCHING]→[IGNORING DURATION].
2. Select the output.
3. Set the ignoring duration to temporarily disable input detection after an auto-input switching event has occurred.

WEB GUI

[MENU]	[AUTO SWITCHING]
CROSS POINT	OUT 1 PinP 1 OUT 2 PinP 2
OUTPUT IMAGE	
OUTPUT SETTINGS	IN1 : 1
INPUT IMAGE	SIGNAL ON PRIORITY IN2 : 1
INPUT SETTINGS	IN3 : 1
AUTO SWITCHING	IN4 : 1
PICTURE ADJUSTMENT	
OUTPUT AUDIO SETTINGS	IN1 : 1
INPUT AUDIO SETTINGS	SIGNAL OFF PRIORITY IN2 : OFF
EDID SETTINGS	IN3 : OFF
RS-232C SETTINGS	IN4 : OFF
LAN SETTINGS	
CONTROL COMMAND	IGNORING DURATION 0 + 0 - 999999ms
USER PRESET	SWITCHING MODE V&A
BITMAP	
POWER ON SETTINGS	
SYSTEM SETTINGS	
VIEW STATUS	

Tip

Only basic menus are displayed by default. To display advanced menus as well, perform the procedure in **“Advanced menu (P.20)”**.

RS-232C/LAN Communication

This chapter describes how to configure communication for the MSD-V4.

Configuring RS-232C communication

Front Panel

1. Select [RS-232C SETTINGS]→[PARAMETERS].
2. Select the connectors supporting RS-232C communication.
3. Configure the following items: [BAUD RATE], [DATA BIT LENGTH], [PARITY], [STOP BIT]
4. Press the MENU/ENTER button to accept the new value.

WEB GUI

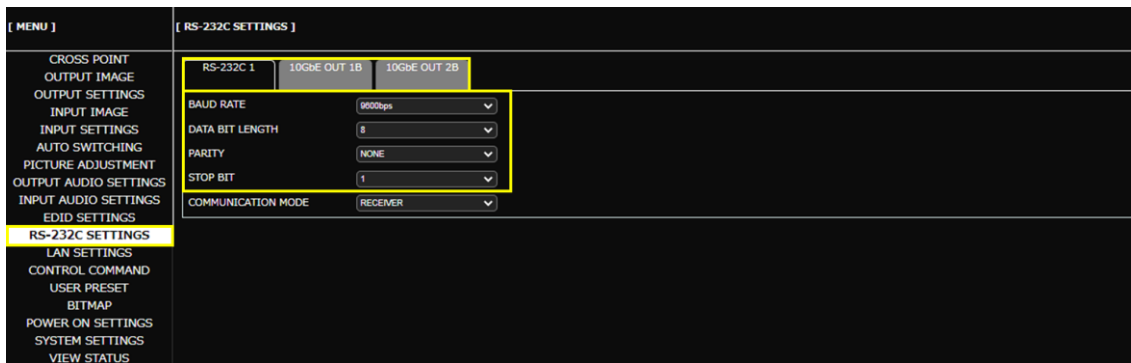

Tip

By default, RS-232C communication is configured as follows:

- Baud rate : 9600 bps
- Data bit length : 8 bits
- Parity check : NONE
- Stop bit : 1 bit

Configuring LAN communication

Front Panel

1. Select [LAN SETTINGS].
2. Configure the following items: [IP ADDRESS], [SUBNET MASK], [GATE WAY]
3. Press the MENU/ENTER button to accept the new values.

WEB GUI

[MENU]

[LAN SETTINGS]

DESTINATION 1 DESTINATION 2 DESTINATION 3 DESTINATION 4 DESTINATION 5 DESTINATION 6 DESTINATION 7 DESTINATION 8

DESTINATION 9 DESTINATION 10 DESTINATION 11 DESTINATION 12

REMOTE IP ADDRESS 192 168 1 98

PjLink OFF

COMMAND DESTINATION

REMOTE PORT NUMBER 800

PjLink PASSWORD

IP ADDRESS 192 168 1 199 SET

SUBNET MASK 255 255 255 0 SET

GATEWAY ADDRESS 192 168 1 200 SET

MAC ADDRESS 00-08-E5-6C-00-1E

OUT1B: 00-08-E5-6E-00-2D

OUT2B: 00-08-E5-6E-00-2E

AUTO DISCONNECT SERVER DISCONNECT 30 1 - 180s

LAN THROUGH OUT1B ON

Notes

- From an external device to the MSD-V4 : Up to eight connections.
- From the MSD-V4 to an external device : Up to 12 connections.

Tips

- By default, RS-232C communication is configured as follows:
 - IP address : 192.168.1.199
 - Subnet mask : 255.255.255.0
 - Default gateway : 192.168.1.200
 - TCP port : 1100 (Fixed)
- By default, LAN communication of extension connectors is configured as follows:
 - 10GbE connector : Disabled
 - HDBaseT connector : Enabled

Projector Power Control

This chapter describes how to command projector power ON/OFF from the MSD-V4.

Tip

For other controls from the MSD-V4, refer to the User Guide.

Controlling projector power via RS-232C communication

Advanced

The examples below show how to control projector power using a function button.

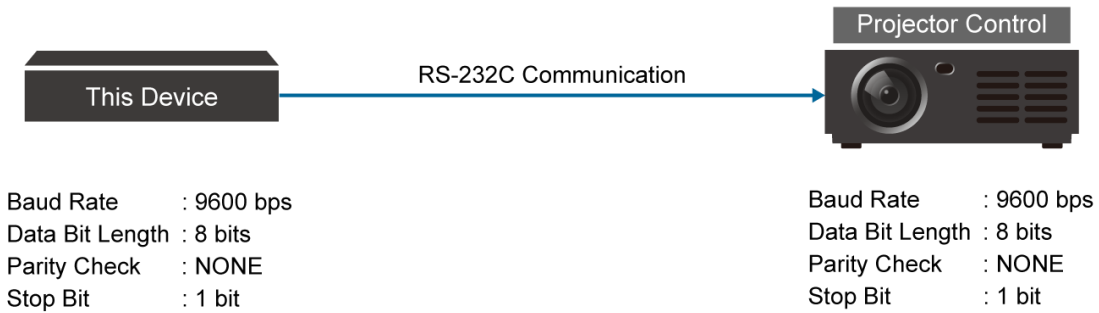

1. By performing “**Configuring RS-232C communication (P.68)**”, configure the RS-232C communication of the MSD-V4 to the same settings as the projector as follows:
2. Set the communication mode to [TRANSMITTER].

Front Panel

- a) Select [RS-232C SETTINGS]→[COMMUNICATION MODE].
- b) Select the RS-232C communication connector.
- c) Select [TRANSMITTER].
- d) Press the MENU/ENTER button to accept the new value.

WEB GUI

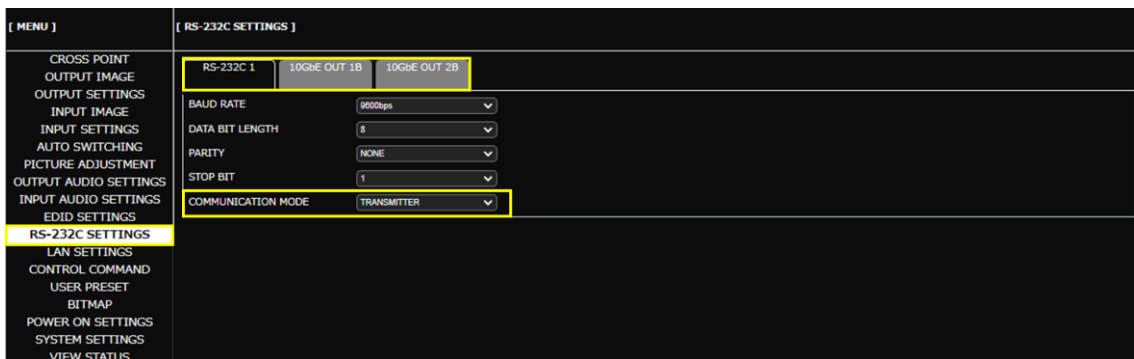

3. Register the two commands for powering on and off the projector to the MSD-V4.

Front Panel

- Select [CONTROL COMMAND]→[COMMAND REGISTER/EDIT].
- Select the command (CMD) number.
- Register the commands as follows:

	CMD1	CMD2
I/F	RS-232C/LAN	RS-232C/LAN
RS1	ON	ON
DATA	Power ON command*	Power OFF command*
DATA SIZE	Transmitting data size	Receiving data size
MEMO	POWER ON	POWER OFF

*For the power control command, refer to the User Guide of the projector.

Note

Only values that need to be changed are shown above.

- Press the MENU/ENTER button to accept the new values.

WEB GUI

Tips

- To register the control commands, you also can use Multi Switcher Configurator or Control Command Configuration Tool, which can be downloaded from www.idkav.com.
- To control registered commands from external devices, send the @EXC command to the MSD-V4. For details, refer to the Command Guide.

4. Assign [DISPLAY POWER] to the F1 button.

Front Panel

- a) Select [SYSTEM SETTING]→[FUNCTION ASSIGNMENT].
- b) Select [F1].
- c) Assign [DISPLAY POWER] to [F1].
- d) Press the MENU/ENTER button.

WEB GUI

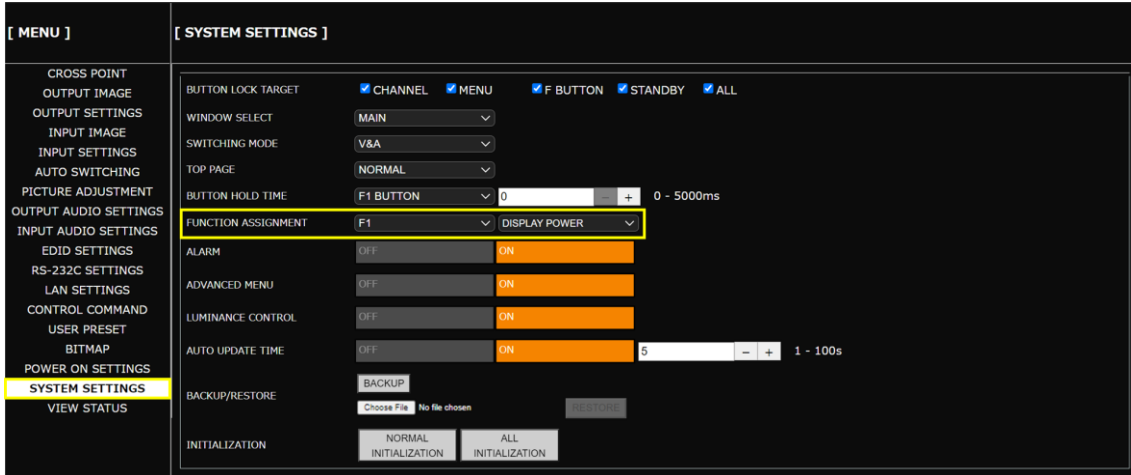

5. Assign the control commands to a function button.

Front Panel

- Select [CONTROL COMMAND]→[COMMAND LINK].
- Select [F1].
- Assign control commands registered in [A-1st] (powering on) and [B-1st] (powering off) to F1 function button.

TOGGLE: ON

A-1st : COMMAND 2

B-1st : COMMAND 1

Note

[A-1st] : Executed by pressing the button LED while lit.

[B-1st] : Executed by pressing the button LED while unlit.

- Press the MENU/ENTER button to accept the new values.

WEB GUI

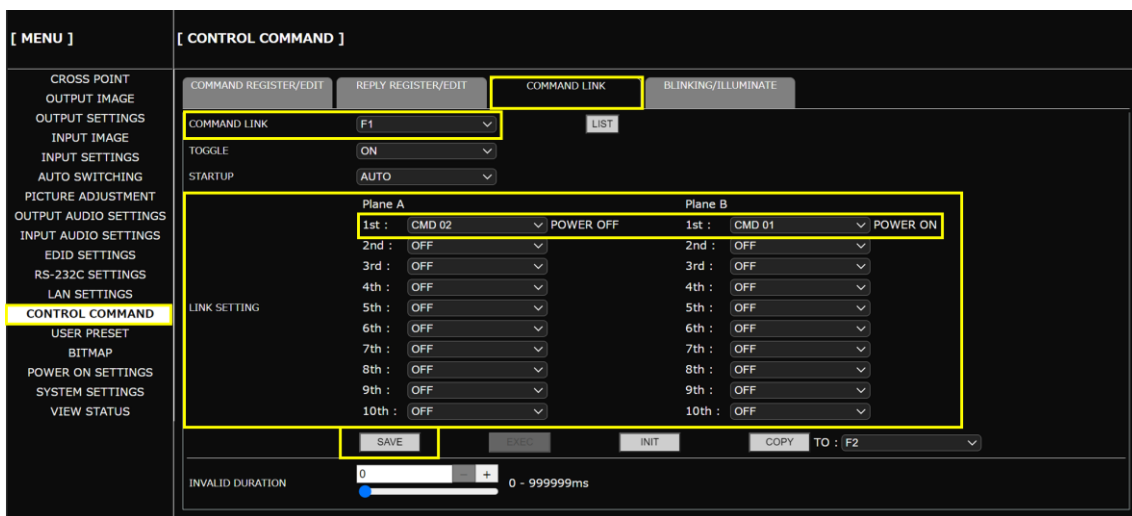

6. Press the assigned function button.
- Press the F1 button while unlit : Powering on projector.
- Press the F1 button while lit : Powering off projector.

Tip

Only basic menus are displayed by default. To display advanced menus as well, perform the procedure in “Advanced menu (P.20)”.

Controlling projector power via PJLink (LAN communication)

Advanced

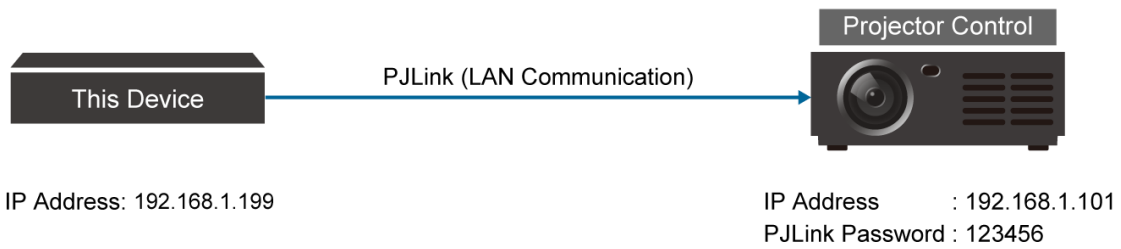

1. Perform the same procedure described in this section “**Configuring LAN communication (P.69)**”.
2. Configure the destination of control command.

Front Panel

- a) Select [LAN SETTINGS]→[COMMAND DESTINATION].
- b) Select [DESTINATION1].
- c) Set the IP address of the projector to [192.168.1.101].
- d) Set [PJLink] to [ON].
- e) Configure the PJLink password to [123456].

Tip

For password of PJLink, refer to the User Guide of the projector.

- f) Press the MENU/ENTER button to accept the new value.

WEB GUI

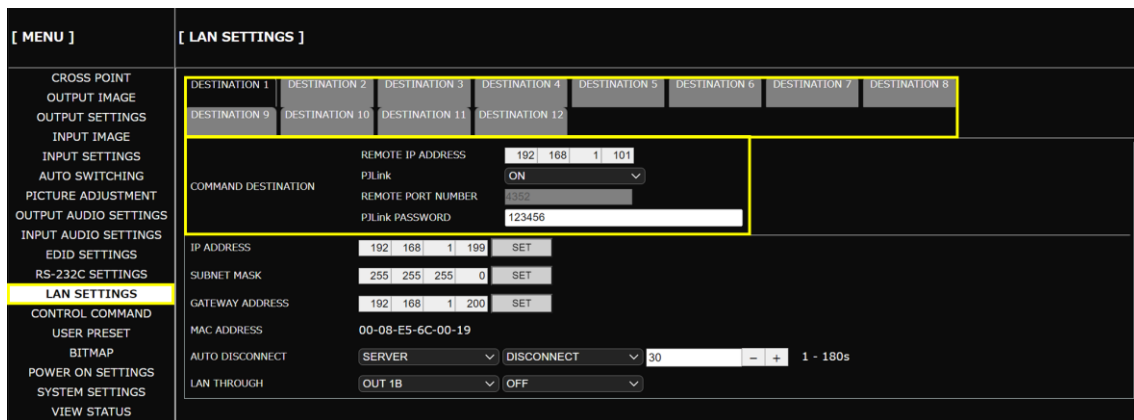

Note

If you do not use PJLink protocol connection, set [PJLink] to [OFF] and set the destination port number.

3. Only if sending the control command from an 10GbE/HDBaseT port, enable the LAN communication of the connector.

Front Panel

- a) Select [LAN SETTINGS]→[LAN THROUGH].
- b) Select the 10GbE/HDBaseT connector.
- c) Set [LAN THROUGH] to [ON].

WEB GUI

[MENU]		[LAN SETTINGS]							
CROSS POINT	DESTINATION 1	DESTINATION 2	DESTINATION 3	DESTINATION 4	DESTINATION 5	DESTINATION 6	DESTINATION 7	DESTINATION 8	
OUTPUT IMAGE	DESTINATION 9	DESTINATION 10	DESTINATION 11	DESTINATION 12					
OUTPUT SETTINGS									
INPUT IMAGE									
INPUT SETTINGS									
AUTO SWITCHING									
PICTURE ADJUSTMENT									
OUTPUT AUDIO SETTINGS									
INPUT AUDIO SETTINGS									
EDID SETTINGS									
RS-232C SETTINGS									
LAN SETTINGS									
CONTROL COMMAND									
USER PRESET									
BITMAP									
POWER ON SETTINGS									
SYSTEM SETTINGS									
VIEW STATUS									
	REMOTE IP ADDRESS	192 168 1 101							
	PiLink	ON							
	COMMAND DESTINATION								
	REMOTE PORT NUMBER	1552							
	PiLink PASSWORD	123456							
	IP ADDRESS	192	168	1	199	SET			
	SUBNET MASK	255	255	255	0	SET			
	GATEWAY ADDRESS	192	168	1	200	SET			
	MAC ADDRESS	00-08-E5-6C-00-19							
	AUTO DISCONNECT	SERVER		DISCONNECT	30		1 - 180s		
	LAN THROUGH	OUT 1B		ON					

Note

The MSD-V4 includes switching hub function. If the MSD-V4 communicates with a product having a switching hub over LAN, the network may be flooded due to a looping condition. In the event of a the loop condition, set the LAN communication to [OFF].

4. Register the two commands for powering a projector on and off on the MSD-V4.

Front Panel

- a) Select [CONTROL COMMAND]→[COMMAND REGISTER/EDIT].
- b) Select the command (CMD) number.
- c) Register the commands as follows:

	CMD1	CMD2
I/F	RS-232C/LAN	RS-232C/LAN
[LAN DESTINATION1]	ON	ON
DATA	%1POWR 1↓	%1POWR 0↓
DATA SIZE	9	9
MEMO	POWER ON	POWER OFF

Note

Only values that need to be changed are shown above.

- d) Press the MENU/ENTER button to accept the new values.

WEB GUI

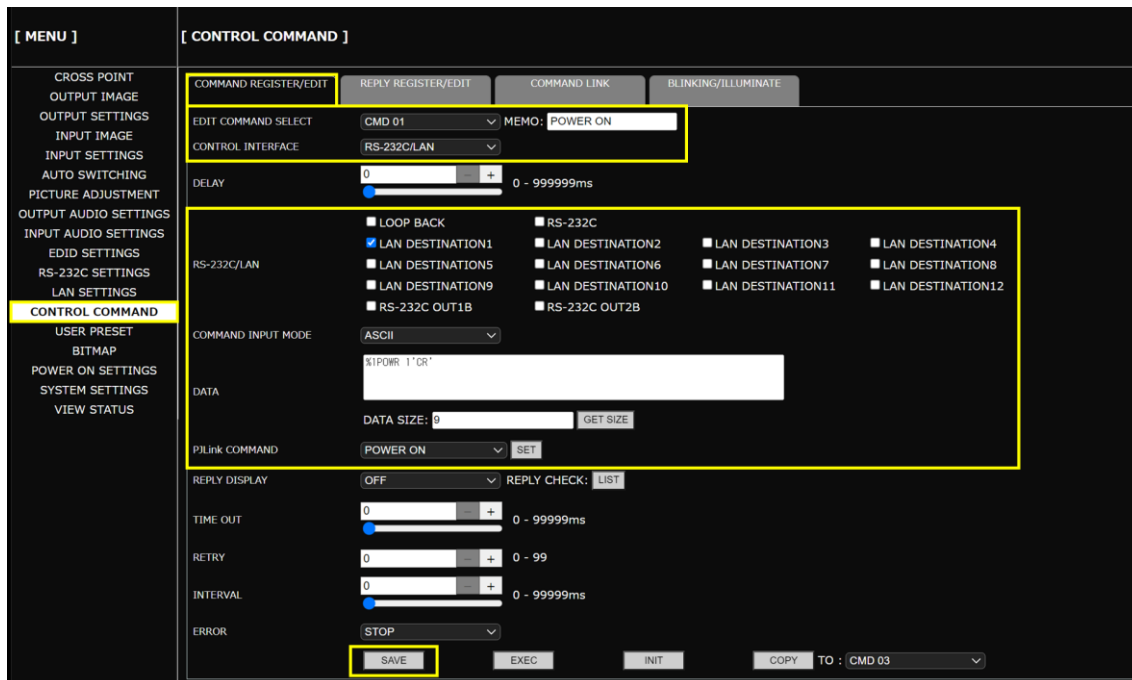

Tips

- To register the control commands, you also can use Multi Switcher Configurator or Control Command Configuration Tool, which can be downloaded from www.idkav.com.
- To control registered commands from external devices, send the @EXC command to the MSD-V4. For details, refer to the Command Guide.

5. Assign [DISPLAY POWER] to a function button.

Front Panel

- Select [SYSTEM SETTING]→[FUNCTION ASSIGNMENT].
- Select [F1].
- Assign [DISPLAY POWER] to [F1].
- Press the MENU/ENTER button to accept the new value.

WEB GUI

[MENU]	[SYSTEM SETTINGS]
CROSS POINT	BUTTON LOCK TARGET <input checked="" type="checkbox"/> CHANNEL <input checked="" type="checkbox"/> MENU <input checked="" type="checkbox"/> F BUTTON <input checked="" type="checkbox"/> STANDBY <input checked="" type="checkbox"/> ALL
OUTPUT IMAGE	WINDOW SELECT <input type="text" value="MAIN"/>
OUTPUT SETTINGS	SWITCHING MODE <input type="text" value="V&A"/>
INPUT IMAGE	TOP PAGE <input type="text" value="NORMAL"/>
INPUT SETTINGS	BUTTON HOLD TIME <input type="text" value="F1 BUTTON"/> <input type="text" value="0"/> <input type="button" value="-"/> <input type="button" value="+"/> 0 - 5000ms
AUTO SWITCHING	FUNCTION ASSIGNMENT <input type="text" value="F1"/> <input type="text" value="DISPLAY POWER"/>
PICTURE ADJUSTMENT	ALARM <input type="text" value="OFF"/> <input type="text" value="ON"/>
OUTPUT AUDIO SETTINGS	ADVANCED MENU <input type="text" value="OFF"/> <input type="text" value="ON"/>
INPUT AUDIO SETTINGS	LUMINANCE CONTROL <input type="text" value="OFF"/> <input type="text" value="ON"/>
EDID SETTINGS	AUTO UPDATE TIME <input type="text" value="OFF"/> <input type="text" value="ON"/> <input type="text" value="5"/> <input type="button" value="-"/> <input type="button" value="+"/> 1 - 100s
RS-232C SETTINGS	BACKUP <input type="button" value="BACKUP"/>
LAN SETTINGS	BACKUP/RESTORE <input type="button" value="Choose File"/> No file chosen
CONTROL COMMAND	INITIALIZATION <input type="button" value="NORMAL"/> <input type="button" value="ALL"/>
USER PRESET	
BITMAP	
POWER ON SETTINGS	
SYSTEM SETTINGS	
VIEW STATUS	

6. Assign the control commands to a function button.

Front Panel

- a) Select [CONTROL COMMAND]→[COMMAND LINK].
- b) Select [F1].
- c) Assign control commands registered in [A-1st] (powering on) and [B-1st] (powering off) to F1 function button.

TOGGLE: ON

A-1st : COMMAND 2

B-1st : COMMAND 1

Note

[A-1st] : Executed by pressing the button LED while lit.

[B-1st] : Executed by pressing the button LED while unlit.

- d) Press the MENU/ENTER button to accept the new values.

WEB GUI

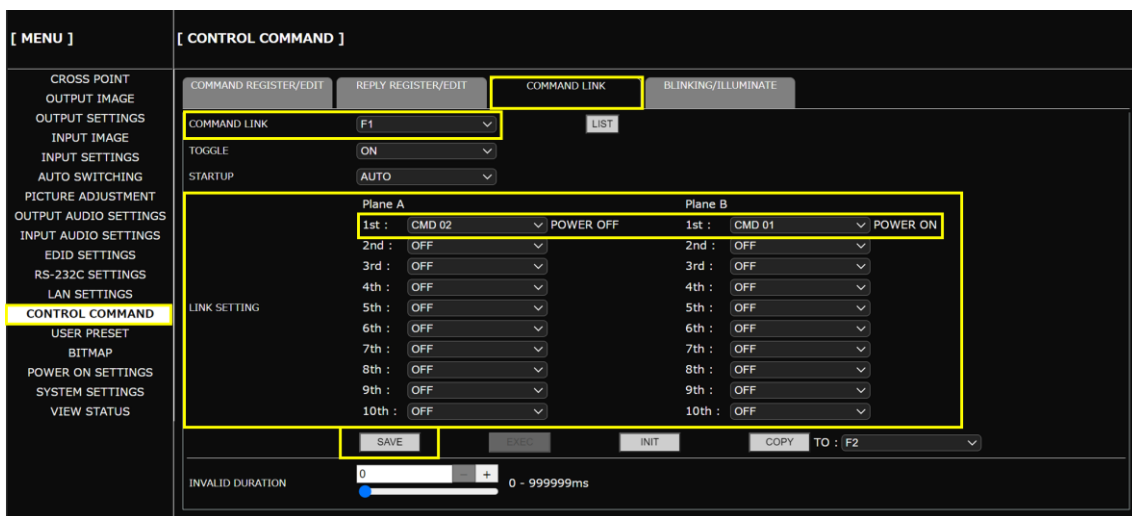

- 7. Press the assigned function button.
 Press the F1 button while unlit : Powering on projector.
 Press the F1 button while lit : Powering off projector.

Tip

Only basic menus are displayed by default. To display advanced menus as well, perform the procedure in “Advanced menu (P.20)”.

Screen Control

This chapter describes how to control a screen via contact closure from the MSD-V4.

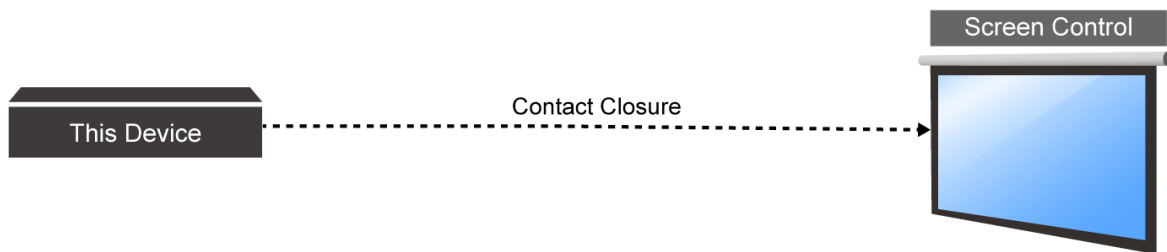

1. Register the three commands for screen up/down/stop in the MSD-V4.

Front Panel

- a) Select [CONTROL COMMAND]→[COMMAND REGISTER/EDIT].
- b) Select the command (CMD) number.
- c) Register the commands as follows:

	CMD3		CMD4		CMD5	
I/F	CONTACT CLOSURE		CONTACT CLOSURE		CONTACT CLOSURE	
CH1	ON	PULSE: 500 ms	OFF	PULSE: NONE	OFF	PULSE: NONE
CH2	OFF	PULSE: NONE	ON	PULSE: 500 ms	OFF	PULSE: NONE
CH3	OFF	PULSE: NONE	OFF	PULSE: NONE	ON	PULSE: 500 ms
MEMO	SCREEN UP		SCREEN STOP		SCREEN DOWN	

Notes

- Only values that need to be changed are shown above.
 - For setting values for [PULSE] of [CH1] to [CH3], refer to the User Guide of the screen.
- d) Press the MENU/ENTER button to accept the new values.

WEB GUI

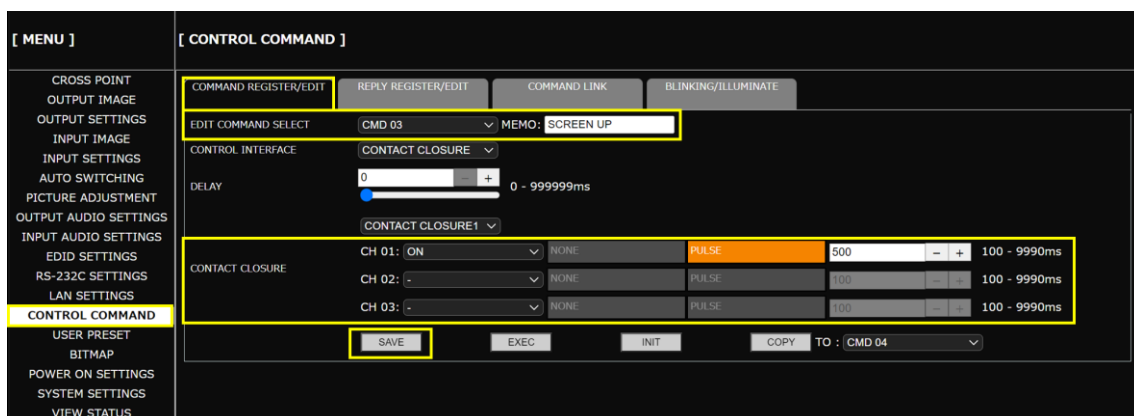

Tips

- To register the control commands, you also can use Multi Switcher Configurator or Control Command Configuration Tool, which can be downloaded from www.idkav.com.
- To control registered commands from external devices, send the @EXC command to the MSD-V4. For details, refer to the Command Guide.

2. Assign [COMMAND] to function buttons for screen up/down/stop.

Front Panel

- a) Select [SYSTEM SETTING]→[FUNCTION ASSIGNMENT].
- b) Assign [COMMAND] to [F2] to [F4].
- c) Press the MENU/ENTER button to accept the new value.

WEB GUI

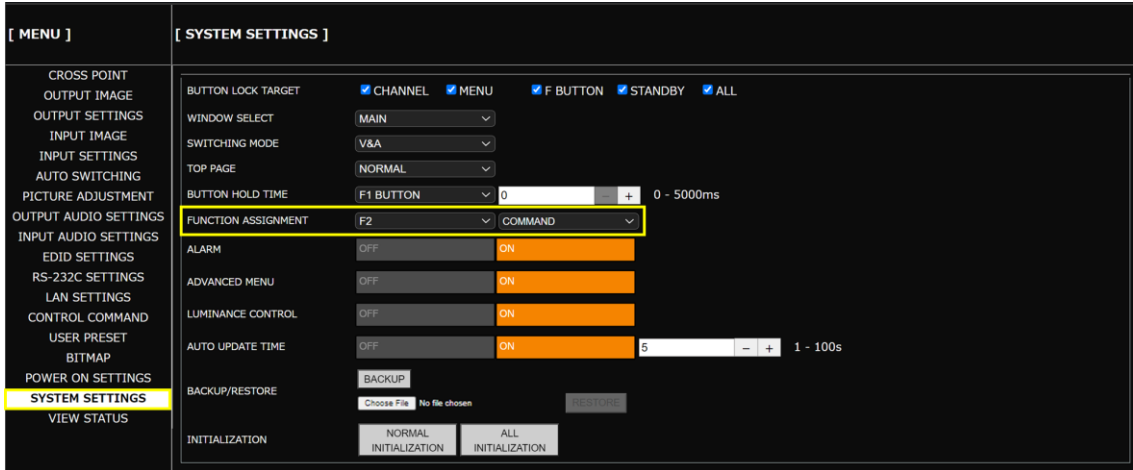

3. Assign commands for screen up/down/stop to function buttons.

Front Panel

- a) Select [CONTROL COMMAND]→[COMMAND LINK].
- b) Select [F2] to [F4].
- c) Assign control commands as follows:

	F2	F3	F4
TOGGLE	OFF	OFF	OFF
1st	COMMAND 3	COMMAND 4	COMMAND 5

- d) Press the MENU/ENTER button.

WEB GUI

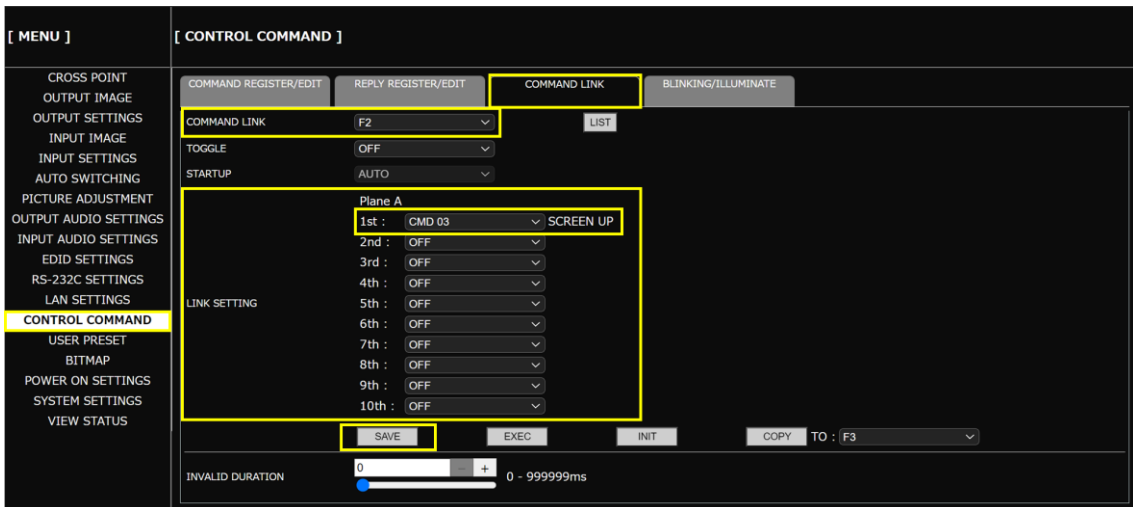

4. Press the assigned function button.
 - Press the lit F2 button : Screen UP
 - Press the lit F3 button : Screen STOP
 - Press the lit F4 button : Screen DOWN

Viewing Status

This chapter describes how to view I/O signal and EDID states of sink devices.
If video or audio cannot be displayed, check signal status using these features.

Viewing input signal status

Front Panel

1. Select [VIEW STATUS]→[INPUT STATUS].
2. Select the input connector.
3. Select the item.

Input video resolution

[IN1 RESOLUTION] ⇄
3840x2160p 59.94Hz

Input video signal format

[IN1 VIDEO FORMAT] ⇄
HDMI 444 8bpc

[IN1 VIDEO FORMAT] ⇄
HDMI 444 8bpc LIMITED

Input audio signal format

[IN1 AUDIO FORMAT] ⇄
L-PCM 48kHz 24bit M

HDCP

[IN1 HDCP STATUS] ⇄
HDCP2.2 Type0

Status of all input connectors

IN1 2 3 4 ◀▶
H_A D H

- [H] : HDMI signal is input.
- [D] : DVI signal is input.
- No character : No signal is input.
- Small [H] : Signal is protected by HDCP.
- Small [A] : Audio is embedded.

WEB GUI

The screenshot shows the WEB GUI interface. On the left is a menu with 'VIEW STATUS' selected. The main area is titled '[VIEW STATUS]' and has tabs for 'OUTPUT/INPUT' and 'HARD'. Under 'OUTPUT/INPUT', there are sub-tabs for 'OUTPUT STATUS', 'SINK DEVICE EDID', and 'INPUT STATUS'. The 'INPUT STATUS' tab is active and shows the following data:

VIDEO STATUS	IN1	IN2	IN3	IN4
RESOLUTION	3840x2160p 60.00Hz	No Signal	No Signal	No Signal
HDMI/DVI	HDMI Mode			
HDCP AUTHENTICATION	: Not Encrypted			
COLOR SPACE	: RGB			
DEEP COLOR	: 8 bpc			
COLOR RANGE	: Limited			
INPUT STATUS	IN1	IN2	IN3	IN4
AUDIO STATUS	IN1	IN2	IN3	IN4
FORMAT	No Signal	No Signal	No Signal	No Signal
SAMPLING FREQUENCY	:			
CHANNEL	:			
SPEAKER	:			
BIT LENGTH	:			

Viewing output signal status

Front Panel

1. Select [VIEW STATUS]→[OUTPUT STATUS].
2. Select the output connector.
3. Select the item.

Output video resolution

[OUT1A RESOLUTION] ↔
3840x2160p 59.94Hz AAA

Output video signal format

[OUT1A VIDEO FORMAT] ↔
HDMI 444 8bpc LIMITED

Output audio signal format

[OUT1A AUDIO FORMAT] ↔
L-PCM 48kHz 24bit M

HDCP

[OUT1A HDCP STATUS] ↔
HDCP2.2 Type0

Status of all output connectors

OUT1A 1B 2A 2B ◀ ▶
L H E

- [H] : Signal is detected with HDCP.
 [L] : Signal is detected but no HDCP present.
 [E] : HDCP authentication failed.
 [C] : Being HDCP authenticated.
 [X] : Video synchronization output is suspended.
 [D] : Sink is disconnected (displayed only for one second).

No character : No sink device is connected or video synchronization output is suspended.

Note

AAA: An error code is displayed. For descriptions of error codes, refer to the User Guide.

WEB GUI

[MENU]	[VIEW STATUS]	OUTPUT/INPUT	HARDWARE		
CROSS POINT OUTPUT IMAGE OUTPUT SETTINGS INPUT IMAGE INPUT SETTINGS AUTO SWITCHING PICTURE ADJUSTMENT OUTPUT AUDIO SETTINGS INPUT AUDIO SETTINGS EDID SETTINGS RS-232C SETTINGS LAN SETTINGS CONTROL COMMAND USER PRESET BITMAP POWER ON SETTINGS SYSTEM SETTINGS VIEW STATUS	OUTPUT STATUS	SINK DEVICE EDID	INPUT STATUS		
	VIDEO STATUS	: HDMI OUT 1A	10GbE OUT 1B	HDMI OUT 2A	10GbE OUT 2B
	RESOLUTION	: 3840x2160p 59.94Hz	Unconnected	3840x2160p 59.94Hz	Unconnected
	HDMI/DVI	: HDMI Mode		HDMI Mode	
	HDCP AUTHENTICATION	: HDCP 2.2		HDCP 2.2	
	COLOR SPACE	: YCbCr444		YCbCr444	
	DEEP COLOR	: 8 bpc		8 bpc	
	COLOR RANGE	: Limited		Limited	
	AUDIO STATUS	: HDMI OUT 1A	10GbE OUT 1B	HDMI OUT 2A	10GbE OUT 2B
	FORMAT	: Linear PCM	Unconnected	Linear PCM	Unconnected
SAMPLING FREQUENCY	: 48kHz		48kHz		
CHANNEL	: 2 Channel		2 Channel		
BIT LENGTH	: 24 bit		24 bit		
ERROR STATUS	VIDEO ERROR	: HDMI OUT 1A	10GbE OUT 1B	HDMI OUT 2A	10GbE OUT 2B
	DIGITAL AUDIO ERROR	:			
	ANALOG AUDIO ERROR	:			

Note

For some sink devices, different signals from the MSD-V4's output setting may be output.

Viewing sink device EDID

This feature is useful for checking the optimal resolution and audio format.

Front Panel

1. Select [VIEW STATUS]→[SINK DEVICE EDID].
2. Select the output connector to which the sink device is connected.
3. Select the item.

Sink device name and recommended resolution

[OUT1A] MONITOR NAME ↔
3840x2160p 594.00MHz

Supported video signal format

[OUT1A] HDMI ↔
RGB/YCbCr422/444

[OUT1A] ↔
DVI

Supported color depth

[OUT1A] ↔
8/10/12 bpc

Supported sampling frequency

[OUT1A] ↔
32/44.1/48/96kHz

Supported audio signal format

[OUT1A] 16/20/24BIT ↔
8CHANNEL COMPRESSED

WEB GUI

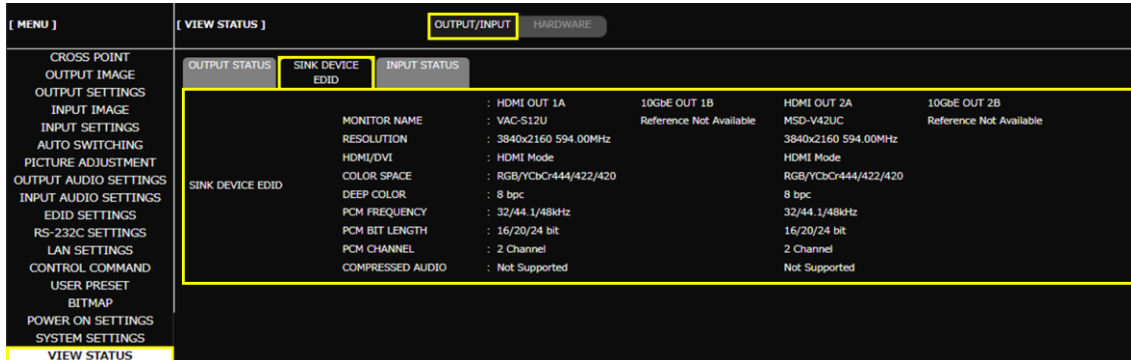

Storing and Recalling Presets

This chapter describes how to store and recall settings to/from the following three types of presets:

- Preset memory : Current input selection of video and audio and output video settings.
- Crosspoint memory : Current input selection of video and audio.
- Pattern memory : Current settings such as image position, image size, and so on.

Tip

For details of settings to be stored as presets, refer to the User Guide.

Storing settings in preset memory

Front Panel

1. Select [USER PRESET]→[STORE PRESET SETTINGS].
2. Select the preset memory number.
3. Enter the desired name.
4. Press the MENU/ENTER button.
The confirmation message appears.
5. Select [YES].
6. Press the MENU/ENTER button.

WEB GUI

[MENU]	[USER PRESET]
CROSS POINT	RECALL CROSSPOINT : [No.1] NAME: [] [LOAD]
OUTPUT IMAGE	
OUTPUT SETTINGS	RECALL PRESET SETTINGS PRESET NUMBER : [No.1] NAME: [] [LOAD] CROSSPOINT : [N/A]
INPUT IMAGE	
INPUT SETTINGS	RECALL PATTERN OUTPUT : [OUT1] NAME: [] [LOAD] PATTERN : [No.1]
INPUT TIMING	
AUTO SWITCHING	STORE CROSSPOINT : [No.1] NAME: [] [SAVE]
PICTURE ADJUSTMENT	
OUTPUT AUDIO SETTINGS	STORE PRESET SETTINGS : [No.1] NAME: [PRESET1] [SAVE]
INPUT AUDIO SETTINGS	
EDID SETTINGS	STORE PATTERN OUTPUT : [OUT1] NAME: [] [SAVE] PATTERN : [No.1]
RS-232C SETTINGS	
LAN SETTINGS	EDIT CROSSPOINT [No.1] NAME: [] MAIN1 VIDEO: [N/A] MAIN1 AUDIO: [N/A] PinP1 VIDEO: [N/A] [SAVE] MAIN2 VIDEO: [N/A] MAIN2 AUDIO: [N/A] PinP2 VIDEO: [N/A]
CONTROL COMMAND	
USER PRESET	COPY OUTPUT SETTINGS [OUT1] -> [OUT2] [SAVE]
BITMAP	START-UP MEMORY [LAST CHANNEL]
POWER ON SETTINGS	
SYSTEM SETTINGS	
VIEW STATUS	

Recalling stored settings from preset memory

Front Panel

1. Select [USER PRESET]→[RECALL PRESET SETTINGS].
2. Select the preset memory number.
3. For [CROSSPOINT], select the input you want to recall with the preset memory.
 [N/A] : No information
 [PRESET] : The input settings stored in the preset memory.
 [CP_MEMORY] : The input settings stored in the crosspoint memory.
4. Press the MENU/ENTER button.
 The confirmation message appears.
5. Select [YES].
6. Press the MENU/ENTER button to accept the new value.

WEB GUI

[MENU]	[USER PRESET]
CROSS POINT	RECALL CROSSPOINT : No.1 NAME: <input type="text"/> <input type="button" value="LOAD"/>
OUTPUT IMAGE	RECALL PRESET SETTINGS PRESET NUMBER : No.1 NAME: PRESET1 <input type="button" value="LOAD"/>
OUTPUT SETTINGS	CROSSPOINT : [PRESET] <input type="button" value="LOAD"/>
INPUT IMAGE	RECALL PATTERN OUTPUT : OUT1 NAME: <input type="text"/> <input type="button" value="LOAD"/>
INPUT SETTINGS	PATTERN : No.1 <input type="button" value="LOAD"/>
INPUT TIMING	STORE CROSSPOINT : No.1 NAME: <input type="text"/> <input type="button" value="SAVE"/>
AUTO SWITCHING	STORE PRESET SETTINGS : No.1 NAME: PRESET1 <input type="button" value="SAVE"/>
PICTURE ADJUSTMENT	STORE PATTERN OUTPUT : OUT1 NAME: <input type="text"/> <input type="button" value="SAVE"/>
OUTPUT AUDIO SETTINGS	PATTERN : No.1 <input type="button" value="SAVE"/>
INPUT AUDIO SETTINGS	EDIT CROSSPOINT MAIN1 VIDEO: N/A MAIN1 AUDIO: N/A PinP1 VIDEO: N/A <input type="button" value="SAVE"/>
EDID SETTINGS	MAIN2 VIDEO: N/A MAIN2 AUDIO: N/A PinP2 VIDEO: N/A <input type="button" value="SAVE"/>
RS-232C SETTINGS	COPY OUTPUT SETTINGS OUT1 -> OUT2 <input type="button" value="SAVE"/>
LAN SETTINGS	START-UP MEMORY LAST CHANNEL <input type="button" value="SAVE"/>
CONTROL COMMAND	
USER PRESET	
BITMAP	
POWER ON SETTINGS	
SYSTEM SETTINGS	
VIEW STATUS	

Storing input selection settings to crosspoint memory

The input channel selections of the currently routed video and audio can be stored to crosspoint memory.

Front Panel

1. Select [USER PRESET]→[STORE CROSSPOINT].
2. Select the crosspoint memory number.
3. Enter the desired name.
4. Press the MENU/ENTER button.
The confirmation message appears.
5. Select [YES].
6. Press the MENU/ENTER button to accept the new values.

WEB GUI

[MENU]	[USER PRESET]
CROSS POINT	RECALL CROSSPOINT : No.1 NAME: <input type="text"/> <input type="button" value="LOAD"/>
OUTPUT IMAGE	RECALL PRESET SETTINGS PRESET NUMBER : No.1 NAME: PRESET1
OUTPUT SETTINGS	CROSSPOINT : N/A
INPUT IMAGE	RECALL PATTERN OUTPUT : OUT1 NAME: <input type="text"/>
INPUT SETTINGS	PATTERN : No.1
INPUT TIMING	STORE CROSSPOINT : No.1 NAME: XPOINT1 <input type="button" value="SAVE"/>
AUTO SWITCHING	STORE PRESET SETTINGS : No.1 NAME: <input type="text"/> <input type="button" value="SAVE"/>
PICTURE ADJUSTMENT	STORE PATTERN OUTPUT : OUT1 NAME: <input type="text"/>
OUTPUT AUDIO SETTINGS	PATTERN : No.1 <input type="button" value="SAVE"/>
INPUT AUDIO SETTINGS	EDIT CROSSPOINT MAIN1 VIDEO: N/A MAIN1 AUDIO: N/A PinP1 VIDEO: N/A
EDID SETTINGS	MAIN2 VIDEO: N/A MAIN2 AUDIO: N/A PinP2 VIDEO: N/A <input type="button" value="SAVE"/>
RS-232C SETTINGS	COPY OUTPUT SETTINGS OUT1 -> OUT2 <input type="button" value="SAVE"/>
LAN SETTINGS	START-UP MEMORY LAST CHANNEL
CONTROL COMMAND	
USER PRESET	
BITMAP	
POWER ON SETTINGS	
SYSTEM SETTINGS	
VIEW STATUS	

Recalling stored input selection settings from crosspoint memory

Front Panel

1. Select [USER PRESET]→[RECALL CROSSPOINT].
2. Select the crosspoint memory number.
3. Press the MENU/ENTER button.

WEB GUI

[MENU]	[USER PRESET]
CROSS POINT	RECALL CROSSPOINT : No.1 NAME: XPOINT1 <input type="button" value="LOAD"/>
OUTPUT IMAGE	RECALL PRESET SETTINGS PRESET NUMBER : No.1 NAME: PRESET1 <input type="button" value="LOAD"/>
OUTPUT SETTINGS	CROSSPOINT : N/A
INPUT IMAGE	RECALL PATTERN OUTPUT : OUT1 NAME: <input type="button" value="LOAD"/>
INPUT SETTINGS	PATTERN : No.1
INPUT TIMING	STORE CROSSPOINT : No.1 NAME: XPOINT1 <input type="button" value="SAVE"/>
AUTO SWITCHING	STORE PRESET SETTINGS : No.1 NAME: <input type="button" value="SAVE"/>
PICTURE ADJUSTMENT	STORE PATTERN OUTPUT : OUT1 NAME: <input type="button" value="SAVE"/>
OUTPUT AUDIO SETTINGS	PATTERN : No.1
INPUT AUDIO SETTINGS	EDIT CROSSPOINT No.1 NAME: XPOINT1
EDID SETTINGS	MAIN1 VIDEO: IN1 MAIN1 AUDIO: IN1 PinP1 VIDEO: OFF <input type="button" value="SAVE"/>
RS-232C SETTINGS	MAIN2 VIDEO: IN1 MAIN2 AUDIO: IN1 PinP2 VIDEO: OFF
LAN SETTINGS	COPY OUTPUT SETTINGS OUT1 -> OUT2 <input type="button" value="SAVE"/>
CONTROL COMMAND	START-UP MEMORY LAST CHANNEL
USER PRESET	
BITMAP	
POWER ON SETTINGS	
SYSTEM SETTINGS	
VIEW STATUS	

Storing layouts in pattern memory

Front Panel

1. Select [USER PRESET]→[STORE PATTERN].
2. Select the output.
3. Select the pattern memory location number.
4. Enter the desired name.
5. Press the MENU/ENTER button.
The confirmation message appears.
6. Select [YES].
7. Press the MENU/ENTER button to accept the new values.

WEB GUI

[MENU]	[USER PRESET]
CROSS POINT	RECALL CROSSPOINT : [No.1] NAME: XPOINT1 [LOAD]
OUTPUT IMAGE	
OUTPUT SETTINGS	RECALL PRESET SETTINGS PRESET NUMBER : [No.1] NAME: PRESET1 [LOAD]
INPUT IMAGE	CROSSPOINT : [N/A]
INPUT SETTINGS	RECALL PATTERN OUTPUT : [OUT1] NAME: PinP PTN1 [LOAD]
INPUT TIMING	PATTERN : [No.1]
AUTO SWITCHING	STORE CROSSPOINT : [No.1] NAME: XPOINT1 [SAVE]
PICTURE ADJUSTMENT	STORE PRESET SETTINGS : [No.1] NAME: [] [SAVE]
OUTPUT AUDIO SETTINGS	STORE PATTERN OUTPUT : [OUT1] NAME: PinP PTN1 [SAVE]
INPUT AUDIO SETTINGS	PATTERN : [No.1]
EDID SETTINGS	[No.1] NAME: XPOINT1
RS-232C SETTINGS	EDIT CROSSPOINT MAIN1 VIDEO: [IN1] MAIN1 AUDIO: [IN1] PinP1 VIDEO: [OFF] [SAVE]
LAN SETTINGS	MAIN2 VIDEO: [IN1] MAIN2 AUDIO: [IN1] PinP2 VIDEO: [OFF] [SAVE]
CONTROL COMMAND	COPY OUTPUT SETTINGS [OUT1] -> [OUT2] [SAVE]
USER PRESET	START-UP MEMORY [LAST CHANNEL]
BITMAP	
POWER ON SETTINGS	
SYSTEM SETTINGS	
VIEW STATUS	

Recalling stored layouts from pattern memory

Front Panel

1. Select [USER PRESET]→[RECALL PATTERN].
2. Select the output.
3. Select the pattern memory location number.
4. Press the MENU/ENTER button.
The confirmation message appears.
5. Select [YES].
6. Press the MENU/ENTER button to accept the new values.

WEB GUI

[MENU]	[USER PRESET]
CROSS POINT	RECALL CROSSPOINT : No.1 NAME: XPOINT1 <input type="button" value="LOAD"/>
OUTPUT IMAGE	PRESET NUMBER : No.1 NAME: PRESET1 <input type="button" value="LOAD"/>
OUTPUT SETTINGS	CROSSPOINT : N/A
INPUT IMAGE	RECALL PATTERN OUTPUT : OUT1 NAME: PinP PTN1 <input type="button" value="LOAD"/>
INPUT SETTINGS	PATTERN : No.1
INPUT TIMING	STORE CROSSPOINT : No.1 NAME: XPOINT1 <input type="button" value="SAVE"/>
AUTO SWITCHING	STORE PRESET SETTINGS : No.1 NAME: <input type="text"/>
PICTURE ADJUSTMENT	STORE PATTERN OUTPUT : OUT1 NAME: PinP PTN1 <input type="button" value="SAVE"/>
OUTPUT AUDIO SETTINGS	PATTERN : No.1
INPUT AUDIO SETTINGS	EDIT CROSSPOINT No.1 NAME: XPOINT1
EDID SETTINGS	MAIN1 VIDEO: IN1 MAIN1 AUDIO: IN1 PinP1 VIDEO: OFF <input type="button" value="SAVE"/>
RS-232C SETTINGS	MAIN2 VIDEO: IN1 MAIN2 AUDIO: IN1 PinP2 VIDEO: OFF
LAN SETTINGS	COPY OUTPUT SETTINGS OUT1 -> OUT2 <input type="button" value="SAVE"/>
CONTROL COMMAND	START-UP MEMORY LAST CHANNEL
USER PRESET	
BITMAP	
POWER ON SETTINGS	
SYSTEM SETTINGS	
VIEW STATUS	

Tip

By default, the following layouts are stored in the pattern memory:

No.1



Main window only

No.2



PinP window is displayed.
(Upper-left)

No.3



PinP window is displayed.
(Upper-right)

No.4



PinP window is displayed.
(Lower-right)

No.5

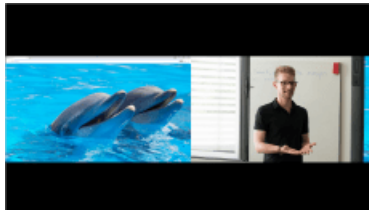

PinP window is displayed.
(Side-by-Side)

Recalling presets at start-up

Front Panel

1. Select [USER PRESET]→[START-UP MEMORY].
2. Select presets you want to recall at the time of start-up.
 - [LAST CHANNEL] : Last settings before powering off or turning to the standby state.
 - [CROSS POINT] : Desired crosspoint.
 - [PRESET MEMORY] : Selected preset.

WEB GUI

[MENU]	[USER PRESET]
CROSS POINT	RECALL CROSSPOINT : [No.1] NAME: XPOINT1 [LOAD]
OUTPUT IMAGE	RECALL PRESET SETTINGS PRESET NUMBER : [No.1] NAME: PRESET1 [LOAD]
OUTPUT SETTINGS	CROSSPOINT : [N/A]
INPUT IMAGE	RECALL PATTERN OUTPUT : [OUT1] NAME: PinP PTN1 [LOAD]
INPUT SETTINGS	PATTERN : [No.1]
INPUT TIMING	STORE CROSSPOINT : [No.1] NAME: XPOINT1 [SAVE]
AUTO SWITCHING	STORE PRESET SETTINGS : [No.1] NAME: [] [SAVE]
PICTURE ADJUSTMENT	STORE PATTERN OUTPUT : [OUT1] NAME: PinP PTN1 [SAVE]
OUTPUT AUDIO SETTINGS	PATTERN : [No.1]
INPUT AUDIO SETTINGS	EDIT CROSSPOINT [No.1] NAME: XPOINT1 [SAVE]
EDID SETTINGS	MAIN1 VIDEO: [IN1] MAIN1 AUDIO: [IN1] PinP1 VIDEO: [OFF]
RS-232C SETTINGS	MAIN2 VIDEO: [IN1] MAIN2 AUDIO: [IN1] PinP2 VIDEO: [OFF]
LAN SETTINGS	COPY OUTPUT SETTINGS [OUT1] -> [OUT2] [SAVE]
CONTROL COMMAND	START-UP MEMORY [LAST CHANNEL]
USER PRESET	
BITMAP	
POWER ON SETTINGS	
SYSTEM SETTINGS	
VIEW STATUS	

Note

If no settings are stored in the preset memory, preset memory is not displayed on the menu.

Backup and Restore

This chapter describes how to back up and restore settings.

All settings can be stored to a PC as a backup file via a WEB browser. The backup file can also be used to copy settings to other MSD-V4 series devices.

Backing up settings

WEB GUI

1. Select [SYSTEM SETTINGS].
2. Click [BACK UP] of [BACKUP/RESTORE].
3. Click [OK].

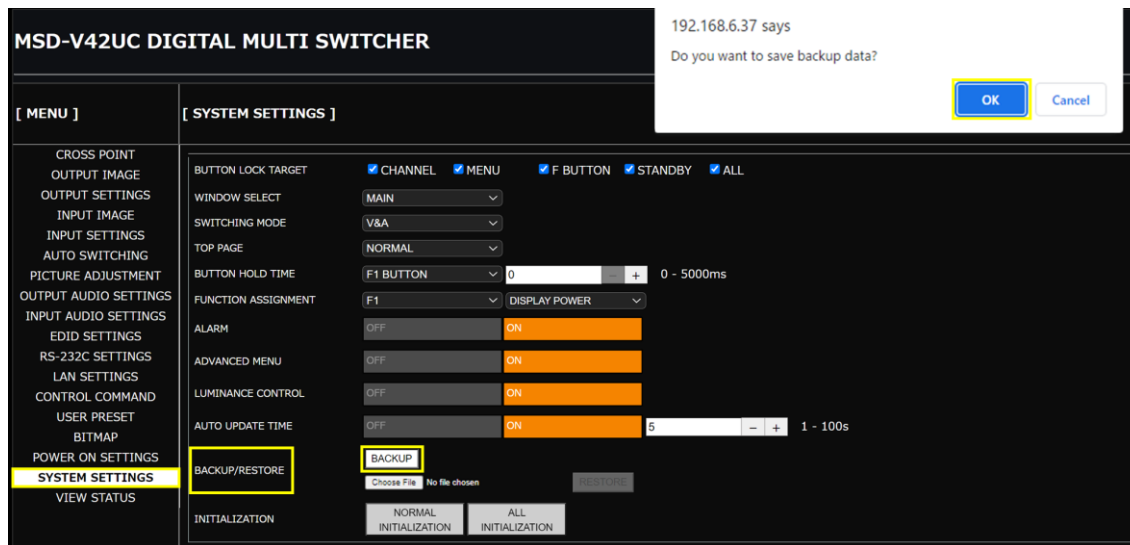

Notes

- A backup file is stored in IDM format.
- Bitmap files cannot be backed up.

Restoring settings from backup file

WEB GUI

1. Select [SYSTEM SETTINGS].
2. Click [Choose File] from [BACKUP/RESTORE].
3. Select the file.
4. Click [SEND].
5. Click [OK].

When the restoring is complete, the MSD-V4 reboots.

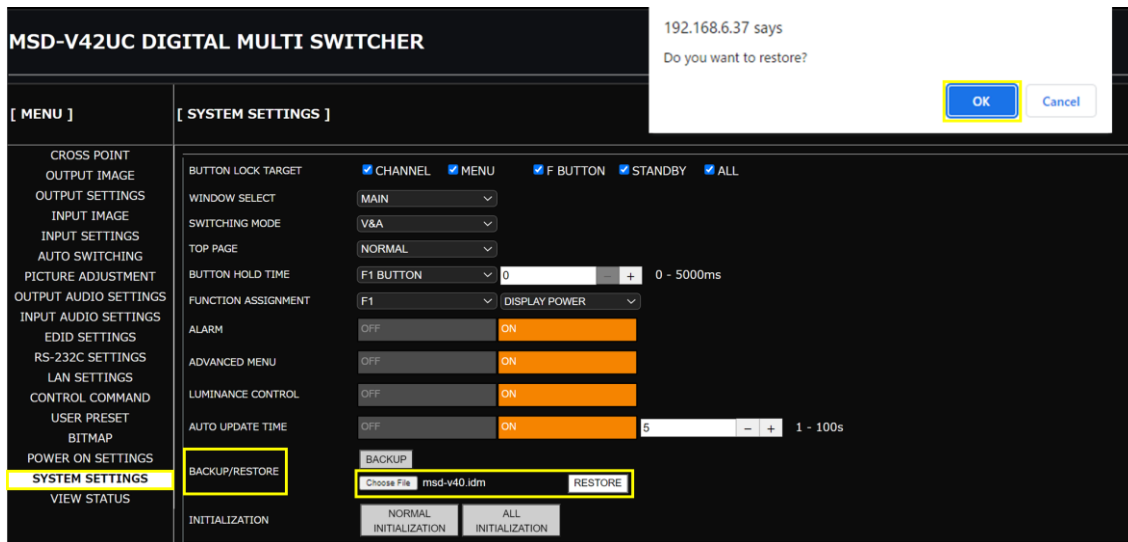

Note

Do not power off the MSD-V4 during the restoring process. The settings may be deleted.

Initialization

This chapter describes how to restore settings to factory-installed defaults.

Notes

- Bitmap files are not initialized.
- Back up setting files for restore before executing the initialization process as needed.

Initializing all settings

Front Panel

1. Press and hold the MENU/ENTER button to boot the MSD-V4.
2. Ensure that a message, [Initializing...] appears on the front panel display.
3. Release the MENU/ENTER button.

WEB GUI

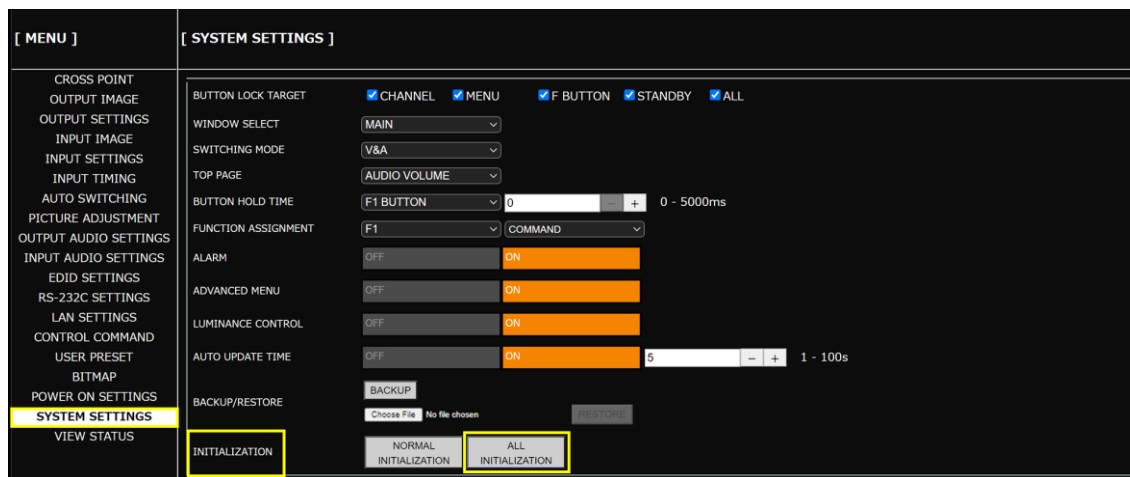

Note

Do not power off the MSD-V4 while the message, [Initializing...] appears on the front panel display. The initialization process may not be completed correctly.

Initializing settings other than LAN/RS-232C configurations

WEB GUI

[MENU]	[SYSTEM SETTINGS]
CROSS POINT	BUTTON LOCK TARGET <input checked="" type="checkbox"/> CHANNEL <input checked="" type="checkbox"/> MENU <input checked="" type="checkbox"/> F BUTTON <input checked="" type="checkbox"/> STANDBY <input checked="" type="checkbox"/> ALL
OUTPUT IMAGE	WINDOW SELECT <input type="text" value="MAIN"/>
OUTPUT SETTINGS	SWITCHING MODE <input type="text" value="V&A"/>
INPUT IMAGE	TOP PAGE <input type="text" value="AUDIO VOLUME"/>
INPUT SETTINGS	BUTTON HOLD TIME <input type="text" value="0"/> 0 - 5000ms
INPUT TIMING	FUNCTION ASSIGNMENT <input type="text" value="F1"/> <input type="text" value="COMMAND"/>
AUTO SWITCHING	ALARM <input type="text" value="OFF"/> <input type="text" value="ON"/>
PICTURE ADJUSTMENT	ADVANCED MENU <input type="text" value="OFF"/> <input type="text" value="ON"/>
OUTPUT AUDIO SETTINGS	LUMINANCE CONTROL <input type="text" value="OFF"/> <input type="text" value="ON"/>
INPUT AUDIO SETTINGS	AUTO UPDATE TIME <input type="text" value="5"/> 1 - 100s
EDID SETTINGS	BACKUP <input type="text" value=""/>
RS-232C SETTINGS	BACKUP/RESTORE <input type="text" value="Choose File"/> No file chosen <input type="text" value="RESTORE"/>
LAN SETTINGS	INITIALIZATION <input type="text" value="NORMAL INITIALIZATION"/> <input type="text" value="ALL INITIALIZATION"/>
CONTROL COMMAND	
USER PRESET	
BITMAP	
POWER ON SETTINGS	
SYSTEM SETTINGS	
VIEW STATUS	

Note

Do not power off the MSD-V4 while the message, [Initializing...] appears on the front panel display. The initialization process may not be completed correctly.

Other useful features

This chapter describes useful features.

Enabling sink device to enter standby mode

Advanced

To command a sink device into standby mode when setting an input to [OFF] or disable the output signal of MSD-V4 when no video signal is available at the input.

Front Panel

1. Select [OUTPUT SETTINGS]→[NO SIGNAL OUTPUT].
2. Select the output connector.
3. Set the response delay time between setting an input to [OFF] or detection of no video input signal and then disabling output signal. (Default: ON)

WEB GUI

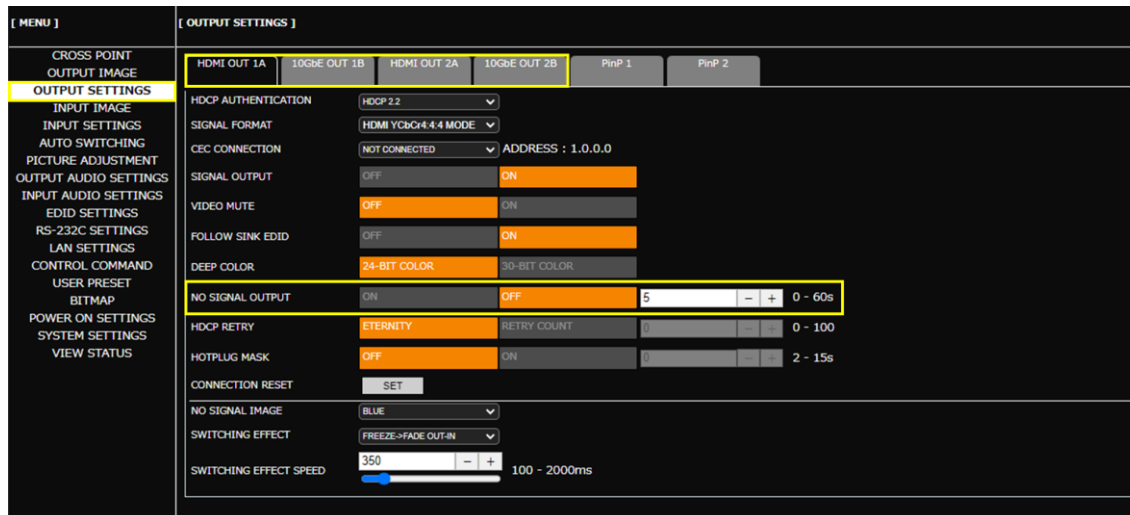

Tips

- For detailed condition requirements, refer to the User Guide.
- Only basic menus are displayed by default. To display advanced menus as well, perform the procedure in “**Advanced menu (P.20)**”.

Troubleshooting

This chapter provides recommendations in case difficulties are encountered during MSD-V4 setup and operation.

In case the MSD-V4 does not work correctly, please check the following items first.

- Are the MSD-V4 and all devices connected to an active power source and are they powered on?
- Are signal cables connected correctly?
- Are there any loose or partially mated connections?
- Are the interconnecting cables specified correctly to support adequate bandwidth?
- Are specifications of connected devices matched to each other?
- Are configuration settings for the connected devices correct?
- Is there any nearby equipment that may cause electrical noise/RF interference?

Use the MSD-V4 built-in status display features to check for input signal presence and format. Also use the status display features to check for the presence of connected sink devices as well as for EDID and HDCP compatibility.

If difficulties persist, please refer to the peripheral device manuals as well, since connected equipment may be the cause of the trouble.

If the trouble persists, please contact us after checking the following items.

- Does the problem occur with all the signal connectors?
- Does the problem occur when you connect the source and display devices directly, bypassing the MSD-V4?

Digital Multi Switcher

MSD-V4 Series

Operation Guide



www.idkav.com

Headquarters

IDK Corporation

7-9-1 Chuo, Yamato, Kanagawa, 242-0021, JAPAN

TEL: +81-46-200-0764 FAX: +81-46-200-0765

Email: idk_eng@idk.co.jp

USA

IDK America Inc.

72 Grays Bridge Road Suite 1-C, Brookfield,
CT 06804, United States

TEL: +1-203-204-2445

Email: sales@idkav.com

Europe

IDK Europe GmbH

Lise-Meitner-Str. 6, D-40878 Ratingen, Germany

TEL: +49-2102-578-301-0

Email: info@idkav.eu

Vietnam

IDK Corporation Vietnam

Hanoi Representative Office

TEL: +84-247-108-8866

Email: info_en@idk.co.jp

IDK Corporation Vietnam

Ho Chi Minh Representative Office

TEL: +84-28-7108-8954

Email: info_en@idk.co.jp